



**Beta**  
motorcycles

CATÁLOGO DE PIEZAS DE REPUESTO

**ZONTES** | R-350 *EURO5*



**350 R**



BETAMOTOR ARGENTINA S.A.

FIG.	NOMBRE	IMAGEN CONJUNTO	IMAGEN DE PARTES	Nº	CÓDIGO	DESCRIPCIÓN	CANT.
1	INSTRUMENTAL TFT			1	ZT1164300012000	INSTRUMENTAL R/V EURO V	1
				2	ZT1250301020093	TUERCA M6	3
				3	ZT1250502010093	ARANDELA ESP. 6.1	3
				4	ZT1244200092000	SILENT-BLOCK INSTRUMENTAL	3
				5	ZT1274200169000	SOPORTE INSTRUMENTAL R1 (TFT)	1
				6	ZT1250205006091	BULON M8X45 GB70.1	1
				7	ZT1250501007093	GROWER 8	1
				8	ZT1251300063093	GRAMPA M6X11X15	1
				9	ZT1251500081000	ARANDELA 8.2X13X1.5	1
2	TAPA DE INSTRUMENTAL TFT			1	ZT1224200128000	TAPA DE INSTRUMENTAL TFT	1
				2	ZT1244100052000	ARANDELA GOMA 8.5X14X1	1
				3	ZT1274100057095	BUJE 6.2X8.5X3.5 + 14X1.5	1
				4	ZT1251100102000	BULON M6X16 (NO STD)	1
				5			
				6			
				7			
				8			
				9			

FIG.	NOMBRE	IMAGEN CONJUNTO	IMAGEN DE PARTES	Nº	CÓDIGO	DESCRIPCIÓN	CANT.
3	MASCARIN AZUL		  	1	ZT4044201013064	CACHA MASCARIN SUP. AZUL	1
				2	ZT4044201023051	MASCARIN GRIS	1
				3	ZT4044302093063	CACHA MASCARIN IZQ. AZUL	1
				4	ZT4044302094063	CACHA MASCARIN DER. AZUL	1
				5	ZT1244200005000	SILENT-BLOCK DE MASCARIN	4
				6	ZT1251300063093	GRAMPA M6X11X15	2
				7	ZT1244100052000	ARANDELA GOMA 8.5X14X1	2
				8	ZT1274100057095	BUJE 6.2X8.5X3.5 + 14X1.5	2
				9	ZT1251100102000	BULON M6X16 (NO STD)	2
4	MASCARIN NEGRO		  	1	ZT4044201013021	CACHA MASCARIN SUP. NEGRO	1
				2	ZT4044201023021	MASCARIN NEGRO	1
				3	ZT4044302091063	CACHA MASCARIN IZQ. NEGRO	1
				4	ZT4044302092021	CACHA MASCARIN DER. NEGRO	1
				5	ZT1244200005000	SILENT-BLOCK DE MASCARIN	4
				6	ZT1251300063093	GRAMPA M6X11X15	2
				7	ZT1244100052000	ARANDELA GOMA 8.5X14X1	2
				8	ZT1274100057095	BUJE 6.2X8.5X3.5 + 14X1.5	2
				9	ZT1251100102000	BULON M6X16 (NO STD)	2













FIG.	NOMBRE	IMAGEN CONJUNTO	IMAGEN DE PARTES	Nº	CÓDIGO	DESCRIPCIÓN	CANT.
5	FARO DELANTERO		  	1	ZT1174300001000	FARO DELANTERO R1 E5	1
				2	ZT1251300063093	GRAMPA M6X11X15	2
				3	ZT1244100052000	ARANDELA GOMA 8.5X14X1	1
			 	4	ZT1274100057095	BUJE 6.2X8.5X3.5 + 14X1.5	1
				5	ZT1251100102000	BULON M6X16 (NO STD)	1
				6			
			7				
			8				
			9				
6	SOPORTE IZQ. SUP FARO DELANTERO		  	1	ZT1274200006000	SOPORTE IZQ. SUP FARO DELANTERO	1
				2	ZT1274300107000	SOPORTE DER. SUP FARO DELANTERO 2	1
				3	ZT1250205040095	BULON M8X16	2
			  	4	ZT1240400007000	SILENT-BLOCK BATERIA	2
				5	ZT1251700059093	BUJE 6.4X9X8 + 18X2	2
				6	ZT1251100102000	BULON M6X16 (NO STD)	2
			7				
			8				
			9				

FIG.	NOMBRE	IMAGEN CONJUNTO	IMAGEN DE PARTES	Nº	CÓDIGO	DESCRIPCIÓN	CANT.
7	CONTRA MASCARIN		  	1	ZT1224200007000	CONTRA MASCARIN	1
				2	ZT1224200008000	GRAPAS PLASTICO DE CABLE	3
				3	ZT1274200007000	SOPORTE INFERIOR FARO DELANTERO	1
				4	ZT1240400007000	SILENT-BLOCK BATERIA	2
				5	ZT1274200024000	PERNO SOPORTE INF. CONTRA MASCARIN	2
				6	ZT1264100006000	SEGUER E	2
				7	ZT1244100052000	ARANDELA GOMA 8.5X14X1	2
				8	ZT1274100057095	BUJE 6.2X8.5X3.5 + 14X1.5	2
				9	ZT1251100102000	BULON M6X16 (NO STD)	5
8	GUARDABARRO DELANTERO NEGRO		  	1	ZT4044302079000	GUARDABARRO DELANTERO NEGRO	1
				2	ZT1251100102000	BULON M6X16 (NO STD)	4
				3	ZT1244100052000	ARANDELA GOMA 8.5X14X1	6
				4	ZT1274100057095	BUJE 6.2X8.5X3.5 + 14X1.5	6
				5	ZT1250301020093	TUERCA M6	2
				6	ZT1251100121093	BULON M8X25	2
				7	ZT1274300109000	PASACABLE FLEXIBLE FRENO DELANTERO	1
				8			
				9			









FIG.	NOMBRE	IMAGEN CONJUNTO	IMAGEN DE PARTES	Nº	CÓDIGO	DESCRIPCIÓN	CANT.
9	GUARDABARRO DELANTERO AZUL		  	1	ZT4044302084051	GUARDABARRO DELANTERO AZUL	1
				2	ZT1251100102000	BULON M6X16 (NO STD)	4
				3	ZT1244100052000	ARANDELA GOMA 8.5X14X1	6
				4	ZT1274100057095	BUJE 6.2X8.5X3.5 + 14X1.5	6
				5	ZT1250301020093	TUERCA M6	2
				6	ZT1251100121093	BULON M8X25	2
				7	ZT1274300109000	PASACABLE FLEXIBLE FRENO DELANTERO	1
				8			
				9			
10	DEFLECTOR AIRE IZQ CARTER AZUL		  	1	ZT4044201089051	DEFLECTOR AIRE IZQ CARTER AZUL	1
				2	ZT1224300006000	REJILLA TOMA AIRE FRONTAL	1
				3	ZT4044201090051	DEFLECTOR AIRE DER CARTER AZUL	1
				4	ZT1251100102000	BULON M6X16 (NO STD)	8
				5	ZT1251300063093	GRAMPA M6X11X15	4
				6	ZT1274100007000	BUJE	4
				7	ZT1244100004000	GOMA SILENT-BLOCK	4
				8	ZT1274100057095	BUJE 6.2X8.5X3.5 + 14X1.5	4
				9	ZT1244100052000	ARANDELA GOMA 8.5X14X1	4







FIG.	NOMBRE	IMAGEN CONJUNTO	IMAGEN DE PARTES	Nº	CÓDIGO	DESCRIPCIÓN	CANT.
11	DEFLECTOR AIRE IZQ CARTER NEGRO			1	ZT4044201093021	DEFLECTOR AIRE IZQ CARTER NEGRO	1
				2	ZT1224300006000	REJILLA TOMA AIRE FRONTAL	1
				3	ZT4044201094021	DEFLECTOR AIRE DER CARTER NEGRO	1
				4	ZT1251100102000	BULON M6X16 (NO STD)	8
				5	ZT1251300063093	GRAMPA M6X11X15	4
				6	ZT1274100007000	BUJE	4
				7	ZT1244100004000	GOMA SILENT-BLOCK	4
				8	ZT1274100057095	BUJE 6.2X8.5X3.5 + 14X1.5	4
				9	ZT1244100052000	ARANDELA GOMA 8.5X14X1	4
12	SOPORTE DER DE DEFLECTOR AIRE CARTER			1	ZT1274300006000	SOPORTE DER DE DEFLECTOR AIRE CARTER	1
				2	ZT1251112005093	BULON M6X75	1
				3	ZT1274300005000	SOPORTE IZQ DE DEFLECTOR AIRE CARTER	1
				4	ZT1251112003093	BULON M6X45	1
				5			
				6			
				7			
				8			
				9			





FIG.	NOMBRE	IMAGEN CONJUNTO	IMAGEN DE PARTES	Nº	CÓDIGO	DESCRIPCIÓN	CANT.
13	TANQUE COMBUSTIBLE			1	ZT4034200001000	TANQUE COMBUSTIBLE	1
				2	ZT1224100033000	TAPA TANQUE COMBUSTIBLE	1
				3	ZT1240300021000	BARRA GOMA DEL DEFLECTOR VIENTO	0.17
				4	ZT1244100002000	SILENT-BLOCK CACHAS TANQUE	4
				5	ZT1050958011000	BOMBA COMBUSTIBLE C/FLOTANTE 350	1
				6	ZT1050954006000	TUBO INYECCIÓN COMBUSTIBLE EFI	1
				7	ZT1250105137093	BULON M6X16	8
				8	ZT1224200066000	SOPORTE DE ANTENA EXTERNA PKE	1
				9			
14	SOPORTE TRASERO TANQUE COMBUSTIBLE			1	ZT1250205043093	BULON M8X55	2
				2	ZT1251900028093	ARANDELA 9X37.5X2	2
				3	ZT1244100020000	GOMA PRESIÓN DE TANQUE COMBUSTIBLE	2
				4	ZT1244100053000	BUJE GOMA DE TANQUE COMBUSTIBLE SEGUNDO	2
				5	ZT1274100080000	SOPORTE TRASERO TANQUE COMBUSTIBLE	1
				6			
				7			
				8			
				9			















FIG.	NOMBRE	IMAGEN CONJUNTO	IMAGEN DE PARTES	Nº	CÓDIGO	DESCRIPCIÓN	CANT.
15	SOPORTE FRONTAL CACHAS TANQUE	 	  	1	ZT1274200013000	SOPORTE FRONTAL CACHAS TANQUE	1
				2	ZT1274200014000	SOPORTE TRASERO CACHAS TANQUE	1
				3	ZT1251100101000	BULON M6X12 (NO STD)	4
				4			
				5			
				6			
				7			
				8			
				9			
16	CACHA TANQUE IZQ. GRIS		        	1	ZT4044302032051	CACHA TANQUE IZQ. GRIS	1
				2	ZT4044201016064	CACHA TANQUE INF. IZQ. AZUL	1
				3	ZT1251300063093	GRAMPA M6X11X15	7
				4	ZT1244100002000	SILENT-BLOCK CACHAS TANQUE	1
				5	ZT1274100007000	BUJE	4
				6	ZT1244100004000	GOMA SILENT-BLOCK	4
				7	ZT1244100052000	ARANDELA GOMA 8.5X14X1	3
				8	ZT1274100057095	BUJE 6.2X8.5X3.5 + 14X1.5	3
				9	ZT1251100102000	BULON M6X16 (NO STD)	7





FIG.	NOMBRE	IMAGEN CONJUNTO	IMAGEN DE PARTES	Nº	CÓDIGO	DESCRIPCIÓN	CANT.
17	CACHA TANQUE IZQ. NEGRO			1	ZT4044302032021	CACHA TANQUE IZQ. NEGRO	1
				2	ZT4044201016051	CACHA TANQUE INF. IZQ. GRIS MATE	1
				3	ZT1251300063093	GRAMPA M6X11X15	7
				4	ZT1244100002000	SILENT-BLOCK CACHAS TANQUE	1
				5	ZT1274100007000	BUJE	4
				6	ZT1244100004000	GOMA SILENT-BLOCK	4
				7	ZT1244100052000	ARANDELA GOMA 8.5X14X1	3
				8	ZT1274100057095	BUJE 6.2X8.5X3.5 + 14X1.5	3
				9	ZT1251100102000	BULON M6X16 (NO STD)	7
18	CACHA TANQUE IZQ. GRIS OSCURO			1	ZT4044201033051	CACHA TANQUE IZQ. GRIS OSCURO	1
				2	ZT4044201016064	CACHA TANQUE INF. IZQ. AZUL	1
				3	ZT1251300063093	GRAMPA M6X11X15	7
				4	ZT1244100002000	SILENT-BLOCK CACHAS TANQUE	1
				5	ZT1274100007000	BUJE	4
				6	ZT1244100004000	GOMA SILENT-BLOCK	4
				7	ZT1244100052000	ARANDELA GOMA 8.5X14X1	3
				8	ZT1274100057095	BUJE 6.2X8.5X3.5 + 14X1.5	3
				9	ZT1251100102000	BULON M6X16 (NO STD)	7



FIG.	NOMBRE	IMAGEN CONJUNTO	IMAGEN DE PARTES	Nº	CÓDIGO	DESCRIPCIÓN	CANT.
19	CACHA TANQUE DER. NEGRO			1	ZT4044302040021	CACHA TANQUE DER. NEGRO	1
				2	ZT4044302090051	CACHA TANQUE INF. DER. GRIS	1
				3	ZT1251300063093	GRAMPA M6X11X15	7
				4	ZT1244100002000	SILENT-BLOCK CACHAS TANQUE	1
				5	ZT1274100007000	BUJE	4
				6	ZT1244100004000	GOMA SILENT-BLOCK	4
				7	ZT1244100052000	ARANDELA GOMA 8.5X14X1	3
				8	ZT1274100057095	BUJE 6.2X8.5X3.5 + 14X1.5	3
				9	ZT1251100102000	BULON M6X16 (NO STD)	7
20	CACHA TANQUE SUP. AZUL			1	ZT4044302036064	CACHA TANQUE SUP. AZUL	1
				2	ZT1184200002000	CERRADURA ELECTRONICA TANQUE COMBUSTIBLE	1
				3	ZT1274100021000	SOPORTE BISAGRA CUBRE TANQUE COMBUSTIBLE	1
				4	ZT1260100215000	CHAVETA	1
				5	ZT1274100090000	EJE BISAGRA TAPA GUANTERA/TANQUE	1
				6	ZT1224100014000	SILENT-BLOCK CACHA SUP TANQUE COMBUSTIBLE	1
				7	ZT4044201019064	TAPA TANQUE AZUL	1
				8	ZT1224100010000	REMACHE PLASTICO EXPANSIÓN	4
				9	ZT1251100102000	BULON M6X16 (NO STD)	2





FIG.	NOMBRE	IMAGEN CONJUNTO	IMAGEN DE PARTES	Nº	CÓDIGO	DESCRIPCIÓN	CANT.
21	CACHA TANQUE SUP. GRIS			1	ZT4044302036051	CACHA TANQUE SUP. GRIS	1
				2	ZT1184200002000	CERRADURA ELECTRONICA TANQUE COMBUSTIBLE	1
				3	ZT1274100021000	SOPORTE BISAGRA CUBRE TANQUE COMBUSTIBLE	1
				4	ZT1260100215000	CHAVETA	1
				5	ZT1274100090000	EJE BISAGRA TAPA GUANTERA/TANQUE	1
				6	ZT1224100014000	SILENT-BLOCK CACHA SUP TANQUE COMBUSTIBLE	1
				7	ZT4044201554051	TAPA TANQUE GRIS	1
				8	ZT1224100010000	REMACHE PLASTICO EXPANSIÓN	4
				9	ZT1251100102000	BULON M6X16 (NO STD)	2
22	CACHA CENTRAL IZQ. AZUL			1	ZT4044302081063	CACHA CENTRAL IZQ. AZUL	1
				2	ZT4044302080063	CACHA CENTRAL DER. AZUL	1
				3	ZT1224100010000	REMACHE PLASTICO EXPANSIÓN	2
				4			
				5			
				6			
				7			
				8			
				9			





FIG.	NOMBRE	IMAGEN CONJUNTO	IMAGEN DE PARTES	Nº	CÓDIGO	DESCRIPCIÓN	CANT.
23	CACHA CENTRAL IZQ. GRIS			1	ZT4044302082051	CACHA CENTRAL IZQ. GRIS	1
				2	ZT4044302083051	CACHA CENTRAL DER. GRIS	1
				3	ZT1224100010000	REMACHE PLASTICO EXPANSIÓN	2
				4			
				5			
				6			
				7			
				8			
				9			
24	FARO GIRO DELANTERO IZQ.			1	ZT1174200004000	FARO GIRO DELANTERO IZQ	1
				2	ZT1174200005000	FARO GIRO DELANTERO DER	1
				3	ZT1244100052000	ARANDELA GOMA 8.5X14X1	6
				4	ZT1274100057095	BUJE 6.2X8.5X3.5 + 14X1.5	6
				5	ZT1251100102000	BULON M6X16 (NO STD)	2
				6	ZT1250303010093	TUERCA M6	2
				7	ZT1251100061093	BULON M6X22	2
				8			
				9			



FIG.	NOMBRE	IMAGEN CONJUNTO	IMAGEN DE PARTES	Nº	CÓDIGO	DESCRIPCIÓN	CANT.
25	CACHA SUPERIOR TANQUE TITANIO			1	ZT1224300090000	CACHA TANQUE PORTA GIRO IZQ.	1
				2	ZT1224300091000	CACHA TANQUE PORTA GIRO DER.	1
				3	ZT1251300063093	GRAMPA M6X11X15	2
				4	ZT1244100052000	ARANDELA GOMA 8.5X14X1	11
				5	ZT1274100057095	BUJE 6.2X8.5X3.5 + 14X1.5	9
				6	ZT1251100102000	BULON M6X16 (NO STD)	12
				7	ZT1184200100000	USB GENERAL DOBLE PUERTO	1
				8	ZT1244100015000	JUNTA DE TUERCA AJUSTE	1
				9	ZT1251500081000	ARANDELA 8.2X13X1.5	2
				10	ZT1224200066000	SOPORTE DE ANTENA EXTERNA PKE	1
				11	ZT1224300083000	PASACABLE INSTALACIÓN DERECHO	1
				12	ZT1224300084000	PASACABLE INSTALACIÓN IZQUIERDO	1
				13	ZT1274100018000	BUJE SEPARADOR SILENCIADOR	1
				14	ZT1244200109000	TAPA USB	1
				15			
				16			
				17			
				18			









FIG.	NOMBRE	IMAGEN CONJUNTO	IMAGEN DE PARTES	Nº	CÓDIGO	DESCRIPCIÓN	CANT.
26	CACHA IZQ. FRONTAL TANQUE GRIS BRILLANTE		  	1	ZT4044201025051	CACHA IZQ. FRONTAL TANQUE GRIS BRILLANTE	1
				2	ZT4044201024051	CACHA DER. FRONTAL TANQUE GRIS BRILLANTE	1
				3	ZT1224100010000	REMACHE PLASTICO EXPANSIÓN	2
			4	ZT1251300063093	GRAMPA M6X11X15	6	
			5				
			6				
			7				
			8				
			9				
27	CACHA IZQ. FRONTAL TANQUE NEGRO		  	1	ZT4044201025021	CACHA IZQ. FRONTAL TANQUE NEGRO	1
				2	ZT4044201024021	CACHA DER. FRONTAL TANQUE NEGRO	1
				3	ZT1224100010000	REMACHE PLASTICO EXPANSIÓN	2
			4	ZT1251300063093	GRAMPA M6X11X15	6	
			5				
			6				
			7				
			8				
			9				





FIG.	NOMBRE	IMAGEN CONJUNTO	IMAGEN DE PARTES	Nº	CÓDIGO	DESCRIPCIÓN	CANT.
28	CAJA PARTES ELECTRICAS			1	ZT1224200161000	CAJA PARTES ELECTRICAS (BATERIA GEL)	1
				2	ZT1251300063093	GRAMPA M6X11X15	6
				3	ZT1251100102000	BULON M6X16 (NO STD)	2
				4	ZT1251513001019	ARANDELA 6.3X12X1.6 COBRE	1
				5	ZT1251100101000	BULON M6X12 (NO STD)	4
				6	ZT1184100010000	RELÉ ARRANQUE	1
				7	ZT1240300007000	GOMA SILENT-BLOCK BATERÍA	3
				8	ZT1050958014000	ECU - EURO 5 350	1
				9	ZT1224200176000	TAPA DE UNIDAD DE CONTROL (ECU)	1
				10	ZT1224200040000	TAPA PKE	1
				11	ZT1274300017000	SOPORTE PUERTO DE CARGA	1
				12	ZT1251200050094	BULON PARKER 3.9X12	1
				13	ZT1184300003000	PUERTO DE CARGA	1
				14	ZT1184100002000	INTERRUPTOR DE DESCARGA	1
				15	ZT1244100082000	CAPUCHÓN DE INTERRUPTOR DE DESCARGA	1
				16			
				17			
				18			







FIG.	NOMBRE	IMAGEN CONJUNTO	IMAGEN DE PARTES	Nº	CÓDIGO	DESCRIPCIÓN	CANT.
29	BATERÍA DE GEL			1	ZT1184200099000	BATERÍA DE GEL ZONTES	1
				2	ZT1244200111000	CINTO FIJACION DE BATERÍA	1
				3	ZT1184300037000	CARGADOR BATERIA GEL E5	1
				4	ZT1274300087000	KIT HERRAMIENTAS 350	1
				5			
				6			
				7			
				8			
				9			
30	SOPORTE DE BATERÍA			1	ZT1274200238000	SOPORTE DE BATERÍA GEL	1
				2	ZT1251100101000	BULON M6X12 (NO STD)	3
				3	ZT1274100057095	BUJE 6.2X8.5X3.5 + 14X1.5	1
				4	ZT1244100052000	ARANDELA GOMA 8.5X14X1	1
				5	ZT1250303010093	TUERCA M6	2
				6	ZT1240300007000	GOMA SILENT-BLOCK BATERÍA	2
				7			
				8			
				9			









FIG.	NOMBRE	IMAGEN CONJUNTO	IMAGEN DE PARTES	Nº	CÓDIGO	DESCRIPCIÓN	CANT.		
31	COLÍN TRASERO IZQ. AZUL					1	ZT4044201421064	COLÍN TRASERO IZQ. AZUL	1
						2	ZT1250105142093	BULON M6X20	1
						3	ZT1251700058093	BUJE 8.2X11X4.5 + 16X1.5	1
						4	ZT1240300071000	ARANDELA GOMA 11X16X1	1
						5	ZT1251100102000	BULON M6X16 (NO STD)	1
						6	ZT1251100101000	BULON M6X12 (NO STD)	1
						7	ZT1244100052000	ARANDELA GOMA 8.5X14X1	1
						8	ZT1274100018000	BUJE SEPARADOR SILENCIADOR	1
						9	ZT1274100057095	BUJE 6.2X8.5X3.5 + 14X1.5	1
32	COLÍN TRASERO DER. AZUL					1	ZT4044201416064	COLÍN TRASERO DER. AZUL	1
						2	ZT1250105142093	BULON M6X20	1
						3	ZT1251700058093	BUJE 8.2X11X4.5 + 16X1.5	1
						4	ZT1240300071000	ARANDELA GOMA 11X16X1	1
						5	ZT1251100102000	BULON M6X16 (NO STD)	1
						6	ZT1251100101000	BULON M6X12 (NO STD)	1
						7	ZT1244100052000	ARANDELA GOMA 8.5X14X1	1
						8	ZT1274100018000	BUJE SEPARADOR SILENCIADOR	1
						9	ZT1274100057095	BUJE 6.2X8.5X3.5 + 14X1.5	1









FIG.	NOMBRE	IMAGEN CONJUNTO	IMAGEN DE PARTES			Nº	CÓDIGO	DESCRIPCIÓN	CANT.
33	COLÍN TRASERO IZQ. NEGRO					1	ZT4044201418021	COLÍN TRASERO IZQ. NEGRO	1
						2	ZT1250105142093	BULON M6X20	1
						3	ZT1251700058093	BUJE 8.2X11X4.5 + 16X1.5	1
						4	ZT1240300071000	ARANDELA GOMA 11X16X1	1
						5	ZT1251100102000	BULON M6X16 (NO STD)	1
						6	ZT1251100101000	BULON M6X12 (NO STD)	1
						7	ZT1244100052000	ARANDELA GOMA 8.5X14X1	1
						8	ZT1274100018000	BUJE SEPARADOR SILENCIADOR	1
						9	ZT1274100057095	BUJE 6.2X8.5X3.5 + 14X1.5	1
34	COLÍN TRASERO DER. NEGRO					1	ZT4044201413021	COLÍN TRASERO DER. NEGRO	1
						2	ZT1250105142093	BULON M6X20	1
						3	ZT1251700058093	BUJE 8.2X11X4.5 + 16X1.5	1
						4	ZT1240300071000	ARANDELA GOMA 11X16X1	1
						5	ZT1251100102000	BULON M6X16 (NO STD)	1
						6	ZT1251100101000	BULON M6X12 (NO STD)	1
						7	ZT1244100052000	ARANDELA GOMA 8.5X14X1	1
						8	ZT1274100018000	BUJE SEPARADOR SILENCIADOR	1
						9	ZT1274100057095	BUJE 6.2X8.5X3.5 + 14X1.5	1



FIG.	NOMBRE	IMAGEN CONJUNTO	IMAGEN DE PARTES	Nº	CÓDIGO	DESCRIPCIÓN	CANT.
35	CUBRE COLIN			1	ZT1224200095000	CUBRE COLIN IZQUIERDO	1
				2	ZT1224200096000	CUBRE COLIN DERECHO	1
				3	ZT1224100010000	REMACHE PLASTICO EXPANSIÓN	2
				4	ZT1251300063093	GRAMPA M6X11X15	2
				5	ZT1251200033093	PARKER ALLEN ST4.2X12	2
				6	ZT1244100052000	ARANDELA GOMA 8.5X14X1	2
				7	ZT1274100057095	BUJE 6.2X8.5X3.5 + 14X1.5	2
				8	ZT1251100102000	BULON M6X16 (NO STD)	2
				9			
				10			
				11			
				12			
				13			
				14			
				15			
				16			
				17			
				18			





FIG.	NOMBRE	IMAGEN CONJUNTO	IMAGEN DE PARTES			Nº	CÓDIGO	DESCRIPCIÓN	CANT.
36	TAPA INF. COLIN TRASERO NEGRO BRILLANTE					1	ZT4044201410051	TAPA INF. COLIN TRASERO NEGRO BRILLANTE	1
						2	ZT1244100002000	SILENT-BLOCK CACHAS TANQUE	4
						3	ZT1244100052000	ARANDELA GOMA 8.5X14X1	2
						4	ZT1274100057095	BUJE 6.2X8.5X3.5 + 14X1.5	2
						5	ZT1251100102000	BULON M6X16 (NO STD)	8
						6	ZT1251100101000	BULON M6X12 (NO STD)	2
						7	ZT1251300063093	GRAMPA M6X11X15	2
						8	ZT1224100010000	REMACHE PLASTICO EXPANSIÓN	2
						9			
37	TAPA INF. COLIN TRASERO NEGRO					1	ZT4044201409021	TAPA INF. COLIN TRASERO NEGRO	1
						2	ZT1244100002000	SILENT-BLOCK CACHAS TANQUE	4
						3	ZT1244100052000	ARANDELA GOMA 8.5X14X1	2
						4	ZT1274100057095	BUJE 6.2X8.5X3.5 + 14X1.5	2
						5	ZT1251100102000	BULON M6X16 (NO STD)	8
						6	ZT1251100101000	BULON M6X12 (NO STD)	2
						7	ZT1251300063093	GRAMPA M6X11X15	2
						8	ZT1224100010000	REMACHE PLASTICO EXPANSIÓN	2
						9			



FIG.	NOMBRE	IMAGEN CONJUNTO	IMAGEN DE PARTES	Nº	CÓDIGO	DESCRIPCIÓN	CANT.
38	FARO TRASERO STOP			1	ZT1174200014000	FARO TRASERO STOP	1
				2	ZT1174200012000	FARO POSICIÓN TRASERO IZQ.	1
				3	ZT1224200054000	SOPORTE IZQ. FARO POSICIÓN TRASERO	1
				4	ZT1174200013000	FARO POSICIÓN TRASERO DER.	1
				5	ZT1224200056000	SOPORTE DER FARO POSICIÓN TRASERO	1
				6	ZT1251300063093	GRAMPA M6X11X15	4
				7			
				8			
				9			
39	SOPORTE COLÍN TRASERO			1	ZT1274200017000	SOPORTE COLÍN TRASERO	1
				2	ZT1251100102000	BULON M6X16 (NO STD)	3
				3	ZT1274100057095	BUJE 6.2X8.5X3.5 + 14X1.5	1
				4	ZT1244100052000	ARANDELA GOMA 8.5X14X1	1
				5			
				6			
				7			
				8			
				9			





FIG.	NOMBRE	IMAGEN CONJUNTO	IMAGEN DE PARTES	Nº	CÓDIGO	DESCRIPCIÓN	CANT.
40	SOPORTE GUARDABARRO TRASERO			1	ZT1020242265021	SOPORTE GUARDABARRO TRASERO	1
				2	ZT1250503006091	ARANDELA GB97.1 Ø10 (ZINC)	2
				3	ZT1250501004091	ARANDELA GB93Ø10 (ZINC)	2
				4	ZT1251100117093	BULON M8X25	2
				5			
				6			
				7			
				8			
				9			
41	SOPORTE GUARDABARRO CORTASPRAY			1	ZT4024200101000	SOPORTE GUARDABARRO CORTASPRAY 350	1
				2	ZT4024200036000	SOPORTE TRAS. GUARDABARRO CONTASPRAY	1
				3	ZT1251100101000	BULON M6X12 (NO STD)	4
				4	ZT1250105137093	BULON M6X16	4
				5	ZT1274100057095	BUJE 6.2X8.5X3.5 + 14X1.5	3
				6	ZT1244100052000	ARANDELA GOMA 8.5X14X1	3
				7	ZT1250501007093	GROWER 8	5
				8	ZT1224200106000	SOPORTE GUARDABARRO TRASERO	1
				9	ZT1251100102000	BULON M6X16 (NO STD)	4





FIG.	NOMBRE	IMAGEN CONJUNTO	IMAGEN DE PARTES	Nº	CÓDIGO	DESCRIPCIÓN	CANT.
42	GUARDABARRO CORTASPRAY			1	ZT1224200091000	GUARDABARRO CORTASPRAY	1
				2	ZT1251300063093	GRAMPA M6X11X15	4
				3	ZT1244100052000	ARANDELA GOMA 8.5X14X1	4
				4	ZT1274100057095	BUJE 6.2X8.5X3.5 + 14X1.5	4
				5	ZT1251100102000	BULON M6X16 (NO STD)	4
				6	ZT1174100002000	OJO GATO TRASERO	1
				7	ZT1244100006000	GOMA TOPE PATENTE	1
				8	ZT1270300273000	PASACABLE FLEX. L=73	1
				9	ZT1244200082000	TAPÓN ADHESIVO	1
43	CONJUNTO LUCES DE GIRO TRASERAS			1	ZT1174200035000	CONJUNTO LUCES DE GIRO TRASERAS	1
				2	ZT1251300063093	GRAMPA M6X11X15	2
				3	ZT1251100102000	BULON M6X16 (NO STD)	4
				4	ZT1250502010093	ARANDELA ESP. 6.1	2
				5	ZT1274100057095	BUJE 6.2X8.5X3.5 + 14X1.5	2
				6	ZT1244100052000	ARANDELA GOMA 8.5X14X1	4
				7	ZT1274100018000	BUJE SEPARADOR SILENCIADOR	2
				8			
				9			



















FIG.	NOMBRE	IMAGEN CONJUNTO	IMAGEN DE PARTES	Nº	CÓDIGO	DESCRIPCIÓN	CANT.		
44	SOPORTE GIROS TRASEROS		  	1	ZT1224200120000	SOPORTE GIROS TRASEROS	1		
				2	ZT1174200019000	FARO GIRO TRAS. IZQ.	1		
				3	ZT1174200020000	FARO GIRO TRAS. DER.	1		
					4	ZT1174200021000	FARO PATENTE	1	
					5				
					6				
					7				
					8				
					9				
45	INSTALACIÓN DE LUCES TRASERAS		  	1	ZT1184200030000	INSTALACIÓN DE LUCES TRASERAS	1		
				2	ZT1274200119000	SOPORTE DE TUBO DE HORQUILLA PLANA TRASERA	4		
				3	ZT1250104006097	BULON M6X12	4		
						4	ZT1251100122093	BULON M8X16	4
						5	ZT1251700058093	BUJE 8.2X11X4.5 + 16X1.5	4
						6	ZT1240300071000	ARANDELA GOMA 11X16X1	4
						7	ZT4044201029051	TAPA INSTALACIÓN DE COLIN TRASERO GRIS BRILLANTE	1
						ZT4044201029021	TAPA INSTALACIÓN DE COLIN TRASERO NEGRO		
						ZT4044202015051	TAPA INSTALACIÓN DE COLIN TRASERO GRIS MATE		

FIG.	NOMBRE	IMAGEN CONJUNTO	IMAGEN DE PARTES			Nº	CÓDIGO	DESCRIPCIÓN	CANT.			
46	PLACA PORTA PATENTE					1	ZT1270300039000	PLACA PORTA PATENTE	1			
						2	ZT1251100101000	BULON M6X12 (NO STD)	2			
						3	ZT1250303010093	TUERCA M6	2			
									4	ZT1250503021093	ARANDELA 8	2
									5			
									6			
									7			
									8			
									9			
47	PLACA PUBLICITARIA TRASERA ZONTES					1	ZT1210201362000	PLACA PUBLICITARIA TRASERA ZONTES	1			
						2	ZT1251100101000	BULON M6X12 (NO STD)	2			
						3	ZT1250303010093	TUERCA M6	2			
									4			
									5			
									6			
									7			
									8			
									9			

FIG.	NOMBRE	IMAGEN CONJUNTO	IMAGEN DE PARTES	Nº	CÓDIGO	DESCRIPCIÓN	CANT.
48	ASIENTO			1	ZT4120100006000	ASIENTO 350	1
				2	ZT1244100024000	GOMA FRONTAL ASIENTO	2
				3	ZT1244300033000	GOMA ASIENTO	4
				4	ZT1244100025000	TOPE SILENT-BLOCK ASIENTO	4
				5	ZT1010502005000	CINTURON SILENT-BLOCK ASIENTO	1
				6	ZT1250303010093	TUERCA M6	2
				7			
				8			
				9			
49	BRIDA SUPERIOR MANUBRIO GRIS			1	ZT1134300012000	BRIDA SUPERIOR MANUBRIO GRIS	1
				2	ZT4044102002051	CUBRE BULON BRIDA SUPERIOR GRIS	4
				3	ZT1250205023000	BULON M8X35 ALLEN	4
				4	ZT4094200005051	BRIDA INFERIOR MANUBRIO GRIS	2
				5	ZT1274200018000	ARANDELA FIJACIÓN BRIDA INFERIOR MANUBRIO	4
				6	ZT1244200008000	BUJE GOMA FIJACIÓN BRIDA MANIBRIO	4
				7	ZT1250105280000	BULON M10X60	2
				8	ZT1251700065000	BUJE 10X12X41	2
				9			







FIG.	NOMBRE	IMAGEN CONJUNTO	IMAGEN DE PARTES			Nº	CÓDIGO	DESCRIPCIÓN	CANT.
50	ASIENTO VERSION 2021					1	ZT1134300017051	MANUBRIO R350 GRIS	1
						2	ZT1184200184000	COMANDO LUCES IZQUIERDO R1	1
						3	ZT1244100041000	PUÑO IZQUIERDO	1
			4	ZT1134300018000	PUNTERA MANUBRIO 350	2			
			5	ZT1154300009000	CABLE ACELERADOR ABRE	1			
			6	ZT1154300010000	CABLE ACELERADOR CIERRA	1			
			7	ZT1251100219000	BULÓN CABEZA ESFÉRICA M5X30	2			
			8						
			9						
			10	ZT1184200185000	COMANDO LUCES DERECHO R1	1			
			11	ZT1244100042000	PUÑO ACELERADOR	1			
			12	ZT1244300042000	HEBILLA GOMA DOBLE	2			
			13	ZT1244300023000	HEBILLA GOMA 50MM	1			
			14						
			15						
			16						
			17						
			18						





FIG.	NOMBRE	IMAGEN CONJUNTO	IMAGEN DE PARTES	Nº	CÓDIGO	DESCRIPCIÓN	CANT.
51	SOPORTE BASE ESPEJO Y LEVA IZQ. GRIS		  	1	ZT1134300013051	SOPORTE BASE ESPEJO Y LEVA IZQ GRIS GK	1
				2	ZT1134300014051	LEVA EMBRAGUE GRIS GK	1
				3	ZT1251100198000	BULON M6×13 - Ø8×20	1
			4	ZT1251300073000	TUERCA M6	1	
			5	ZT1184200170000	BULBO DE EMBRAGUE	1	
			6	ZT1250201039000	BULON M4X12	1	
			7	ZT1244300051000	CONECTOR CABLE DE EMBRAGUE GK	1	
			8	ZT1190100408051	ESPEJO IZQUIERDO GRIS	1	
			9	ZT1154300001000	CABLE EMBRAGUE R350	1	
			10	ZT1184300019000	BRIDA FIJ. LEVA EMBRAGUE/COMANDO IZQ.TFT 350	1	
			11	ZT1250205031091	BULON M6X30	2	
			12				
			13				
			14				
			15				
			16				
			17				
			18				





FIG.	NOMBRE	IMAGEN CONJUNTO	IMAGEN DE PARTES	Nº	CÓDIGO	DESCRIPCIÓN	CANT.
52	BOMBA FRENO DELANTERO GRIS			1	ZT1100100831000	BOMBA FRENO DELANTERO GRIS	1
				2	ZT1100100833000	LEVA FRENO DELANTERO GRIS	1
				3	ZT1186200012000	BRIDA FIJ. LEVA FRENO/COMANDO DER.TFT 350	1
			4	ZT1250205031091	BULON M6X30	2	
			5	ZT1190100409051	ESPEJO DERECHO GRIS	1	
			6	ZT1251100112000	BULON FLEXIBLE FRENO M10X1X22	1	
			7	ZT1251513013000	ARANDELA COBRE 10.2X15X1.5	2	
			8	ZT1100100827000	PASTILLA FRENO DELANTERO 104HH	1	
			9	ZT1100100092000	PASTILLA FRENO TRASERO HS10	1	
			10	ZT1100100583000	BULBO FRENO DELANTERO	1	
			11				
			12				
			13				
			14				
			15				
			16				
			17				
			18				



FIG.	NOMBRE	IMAGEN CONJUNTO	IMAGEN DE PARTES	Nº	CÓDIGO	DESCRIPCIÓN	CANT.
53	SOPORTE UNIDAD CONTROL ABS			1	ZT1274300071094	SOPORTE UNIDAD CONTROL ABS	1
				2	ZT1251112001093	BULON M6X16	2
				3	ZT1274100007000	BUJE	2
				4	ZT1244100004000	GOMA SILENT-BLOCK	2
				5	ZT1251100102000	BULON M6X16 (NO STD)	2
				6	ZT1250501010000	GROWER 6	2
				7	ZT1274300065000	SOPORTE FLEXIBLE FRENO DELANTERO	1
				8	ZT1250105138093	BULON M6X20	1
				9	ZT1010407002000	PASATUBO DOBLE	1
54	BULON FLEXIBLE FRENO M10X1X22			1	ZT1251100112000	BULON FLEXIBLE FRENO M10X1X22	1
				2	ZT1251100101000	BULON M6X12 (NO STD)	1
				3	ZT1251112001093	BULON M6X16	2
				4	ZT1244300019000	TAPON GOMA CALIPER	1
				5	ZT1251100307000	BULON FLEXIBLE FRENO M10X1X22	1
				6	ZT1100100895000	VALVULA PURGA CALIPER	1
				7	ZT1251513013000	ARANDELA COBRE 10.2X15X1.5	6
				8	ZT1251100303093	BULON ALLEN M10X1.5X60	2
				9			















FIG.	NOMBRE	IMAGEN CONJUNTO	IMAGEN DE PARTES			Nº	CÓDIGO	DESCRIPCIÓN	CANT.
55	CABEZAL HORQUILLA GRIS					1	ZT4094300001051	CABEZAL HORQUILLA GRIS	1
						2	ZT1251500100000	ARANDELA SUP CAÑO VELA	1
						3	ZT1251300088000	TUERCA SUP. CAÑO VELA	1
						4	ZT1250205023000	BULON M8X35 ALLEN	2
						5	ZT1184200139000	TRABA DE MANUBRIO (NUEVA)	1
						6	ZT1251100121093	BULON M8X25	2
						7	ZT1250501007093	GROWER 8	2
						8			
						9			
56	JUNTA BLOCKQUEO TUERCA CAÑO VELA					1	ZT1134100007000	JUNTA BLOCKQUEO TUERCA CAÑO VELA	1
						2	ZT1251300046093	TUERCA CAÑO VELA M24X1	2
						3	ZT1244100015000	JUNTA DE TUERCA AJUSTE	1
						4	ZT1130900022000	ANILLO ESFERAS	1
						5	ZT1130900024000	PISTA SUPEROR	1
						6	ZT1244300014000	GUARDAPOLVO SUPERIOR CAÑO VELA	1
						7			
						8			
						9			







FIG.	NOMBRE	IMAGEN CONJUNTO	IMAGEN DE PARTES	Nº	CÓDIGO	DESCRIPCIÓN	CANT.
57	CRISTO CON CAÑO VELA GRIS			1	ZT4094300002051	CRISTO CON CAÑO VELA GRIS	1
				2	ZT1244300015000	GUARDAPOLVO INFERIOR CAÑO VELA	1
				3	ZT1134300003000	PISTA INFERIOR	1
				4	ZT1134300002000	ANILLO ESFERAS INFERIOR	1
				5	ZT1250205023000	BULON M8X35 ALLEN	4
				6			
			7				
			8				
			9				
58	HORQUILLA IZQUIERDA GRIS			1	ZT1114300012000	HORQUILLA IZQUIERDA GRIS	1
				2	ZT1114300013000	HORQUILLA DERECHA GRIS	1
				3	ZT1250205023000	BULON M8X35 ALLEN	4
				4	ZT1274300008000	BUJE DISTANCIADOR IZQ. DELANTERO	2
				5	ZT1094100063000	EJE DELANTERO M20X243	1
				6	ZT1094100037000	BUJE FIJ. DER. EJE DELANTERO	1
			7	ZT1174300013000	OJO DE GATO HORQUILLAS	2	
			8				
			9				

FIG.	NOMBRE	IMAGEN CONJUNTO	IMAGEN DE PARTES	Nº	CÓDIGO	DESCRIPCIÓN	CANT.
59	LLANTA DELANTERA 17" NEGRA			1	ZT1094300007021	LLANTA DELANTERA 17" NEGRA	1
				2	ZT1230100558000	CUBIERTA R17 120/70 TLE4	1
				3	ZT1100100783000	DISCO FRENO DELANTERO 320X5	1
				4	ZT1251100117093	BULON M8X25	5
				5	ZT1184300034000	SENSOR TPM M8 R1	1
				6	ZT1244200135000	RETEN 28X42X7	2
				7	ZT1250601119000	RODAMIENTO 6004-2RS-C3	2
				8			
				9			
60	DISCO SENSOR ABS 60			1	ZT1274300007000	DISCO SENSOR ABS 60 - 350	1
				2	ZT1250402002000	REMACHE 3.2X9	5
				3	ZT1181200118000	SENSOR VELOCIDAD ABS (A)	1
				4	ZT1251100101000	BULON M6X12 (NO STD)	1
				5	ZT1224100044000	GRAMPA CABLE SENSOR VELOCIDAD	4
				6			
				7			
				8			
				9			





FIG.	NOMBRE	IMAGEN CONJUNTO	IMAGEN DE PARTES	Nº	CÓDIGO	DESCRIPCIÓN	CANT.
61	HORQUILLÓN MONOBRAZO GRIS			1	ZT4074200003051	HORQUILLÓN MONOBRAZO GRIS	1
				2	ZT1252200040000	EJE HORQUILLÓN	1
				3	ZT1251300067000	TUERCA EJE TRASERO	1
				4	ZT1274100102000	BUJE HORQUILLÓN TRASERO	2
				5	ZT1250602035000	RODAMIENTO AGUJAS HK2516	4
				6	ZT1244200079000	RETÉN Ø25xØ32x4	4
				7	ZT1251100204000	BULÓN (NO STD) M16x1.5x50	1
				8	ZT1244200086000	TAPÓN DE GOMA ANTI POLVO IZQ	1
				9	ZT1244200085000	TAPÓN DE GOMA ANTI POLVO DER	1
				10	ZT1244200101000	TAPÓN GOMA HORQUILLON MONOBRAZO	1
62	GUÍA CADENA SUPERIOR R2			1	ZT1244200055000	GUÍA CADENA SUPERIOR R2	1
				2	ZT1274200127000	SOPORTE FIJACIÓN GUÍA CADENA SUPERIOR	1
				3	ZT1274100057095	BUJE 6.2X8.5X3.5 + 14X1.5	5
				4	ZT1251100102000	BULON M6X16 (NO STD)	5
				5			
				6			
				7			
				8			









FIG.	NOMBRE	IMAGEN CONJUNTO	IMAGEN DE PARTES	Nº	CÓDIGO	DESCRIPCIÓN	CANT.
63	GUARDABARRO INTERIOR CUBRECADENA		  	1	ZT1224300087000	GUARDABARRO INTERIOR CUBRECADENA	1
				2	ZT1251100102000	BULON M6X16 (NO STD)	2
				3	ZT1250104006097	BULON M6X12	3
				4	ZT1274100057095	BUJE 6.2X8.5X3.5 + 14X1.5	5
				5	ZT1244100052000	ARANDELA GOMA 8.5X14X1	5
				6	ZT1210343056000	CALCO CUBRE CADENA	1
				7	ZT1210342424000	STICKER RACING	1
				8			
				9			
64	AMORTIGUADOR TRASERO R1		  	1	ZT1114300007000	AMORTIGUADOR TRASERO R1	1
				2	ZT1251112019000	BULON M12X85X1.25	1
				3	ZT1250305009091	TUERCA M12X1.25	1
				4	ZT1251100132003	BULON M10X1.5X80	1
				5	ZT1251300057093	TUERCA M10X1.5	1
				6			
				7			
				8			
				9			

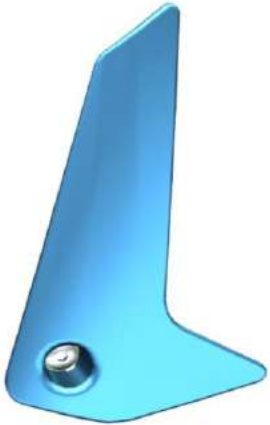







FIG.	NOMBRE	IMAGEN CONJUNTO	IMAGEN DE PARTES	Nº	CÓDIGO	DESCRIPCIÓN	CANT.
65	CUBRE CORONA AZUL		  	1	ZT4044201263063	CUBRE CORONA AZUL	1
				2	ZT1251100101000	BULON M6X12 (NO STD)	1
				3	ZT1274100057095	BUJE 6.2X8.5X3.5 + 14X1.5	1
			4	ZT1244100052000	ARANDELA GOMA 8.5X14X1	1	
			5				
			6				
			7				
			8				
			9				
66	CUBRE CORONA NEGRO		  	1	ZT4044201264021	CUBRE CORONA NEGRO	1
				2	ZT1251100101000	BULON M6X12 (NO STD)	1
				3	ZT1274100057095	BUJE 6.2X8.5X3.5 + 14X1.5	1
			4	ZT1244100052000	ARANDELA GOMA 8.5X14X1	1	
			5				
			6				
			7				
			8				
			9				





FIG.	NOMBRE	IMAGEN CONJUNTO	IMAGEN DE PARTES	Nº	CÓDIGO	DESCRIPCIÓN	CANT.
67	PORTA CORONA MONOBRAZO GRIS			1	ZT4024200086051	PORTA CORONA MONOBRAZO GRIS	1
				2	ZT1274100108000	BUJE $\Phi 45 \times \Phi 35 \times 5.5 + \Phi 54 \times \Phi 35 \times 2$	1
				3	ZT1244200045000	RETÉN $\Phi 45 \times \Phi 55 \times 5$	1
				4	ZT1250601095000	RODAMIENTO ANGULAR DA355520-2RS	1
				5	ZT1274100105000	BUJE $\Phi 46 \times \Phi 35 \times 7.3$	1
				6	ZT1244200088000	O-RING ( $\Phi 52.4 \times 2.6$ )	1
				7	ZT1094200013000	PORTA MANCHON DE CORONA	1
				8	ZT1244100087000	MANCHÓN CORONA	5
				9			
68	CORONA Z43 520			1	ZT1080100112000	CORONA Z43 520	1
				2	ZT1080200055000	CADENA 520HX R114 CON UNIÓN (V2)	1
				3	ZT1251300057093	TUERCA M10X1.5	5
				4	ZT1251100190000	BULÓN NO STD M10×1.5×30	5
				5			
				6			
				7			
				8			
				9			

FIG.	NOMBRE	IMAGEN CONJUNTO	IMAGEN DE PARTES	Nº	CÓDIGO	DESCRIPCIÓN	CANT.
69	MASA TRASERA EXCÉNTRICA COMPL.			1	ZT4024200046000	MASA TRASERA EXCÉNTRICA COMPL.	1
				2	ZT1250700009000	CHAVETA $\Phi 75 \times 2.5$	1
				3	ZT1244200044000	RETÉN $\Phi 50 \times \Phi 62 \times 5$	2
				4	ZT1250700008000	CHAVETA $\Phi 62 \times 2$	2
				5	ZT1250602034000	RODAMIENTO AGUJAS NK50/25	1
				6	ZT1250601094000	RODAMIENTO GBT 276-61908-2RS/P6	2
				7	ZT1274100104000	BUJE $\Phi 50 \times \Phi 40 \times 7.5$	1
				8			
				9			
70	PLACA MONTAJE CALIPER TRASERO GRIS			1	ZT4024300010000	PLACA MONTAJE CALIPER TRASERO GRIS	1
				2	ZT1251500096000	ARANDELA $\Phi 90 \times \Phi 76$	1
				3	ZT1244200105000	O-RING $\Phi 80 \times 2.65$	1
				4	ZT1100100732051	PERNO GUIA CALIPER TRAS. GRIS	1
				5	ZT1244200066000	O-RING ( $\Phi 22.2 \times 2.4$ )	1
				6	ZT1251100123093	BULON M8X25	2
				7	ZT1181200118000	SENSOR VELOCIDAD ABS (A)	1
				8	ZT1251100101000	BULON M6X12 (NO STD)	1
				9			

FIG.	NOMBRE	IMAGEN CONJUNTO	IMAGEN DE PARTES	Nº	CÓDIGO	DESCRIPCIÓN	CANT.
71	EJE TRASERO MONO BRAZO			1	ZT4024200048000	EJE TRASERO MONO BRAZO	1
				2	ZT1251100191000	BULÓN NO STD M12x1.5x38	5
				3	ZT1250305002091	TUERCA M8	5
				4	ZT1251100117093	BULON M8X25	5
				5	ZT1100100784000	DISCO FRENO TRASERO 265X4.5	1
				6	ZT1274200058000	DISCO SISTEMA ABS 60 DIENTE	1
				7	ZT1251300070000	TUERCA NO STD M35x1.5	1
				8	ZT1094100062000	CHAVETA M35	1
				9			
72	LLANTA TRASERA 17" NEGRA			1	ZT1094300008000	LLANTA TRASERA 17" NEGRA	1
				2	ZT1230100564000	CUBIERTA R17 160/60	1
				3	ZT1251300071000	TUERCA NO STD M12x1.5 (CROMADO)	1
				4	ZT1210142000100	TAPON CENTRO LLANTA NEGRO	1
				5	ZT1260100238000	CHAVETA LLANTA TRASERA	1
				6	ZT1184300034000	SENSOR TPM M8 R1	1
				7			
				8			
				9			

















FIG.	NOMBRE	IMAGEN CONJUNTO	IMAGEN DE PARTES	Nº	CÓDIGO	DESCRIPCIÓN	CANT.
73	CUADRO R350		  	1	ZT4014300009000	CUADRO R350	1
				2	ZT1251100262000	BULON M12X127X1.25	1
				3	ZT1250305009091	TUERCA M12X1.25	1
			  	4	ZT1244100019000	GOMA POSICIÓN INTERNO DE TANQUE	1
				5	ZT1244100002000	SILENT-BLOCK CACHAS TANQUE	8
				6	ZT1244100061000	TAPON DE CUADRO	4
			  	7	ZT1240300007000	GOMA SILENT-BLOCK BATERÍA	1
				8	ZT1130900026000	CUBETA CUADRO	1
				9	ZT1134300001000	CUBETA CUADRO INFERIOR	1
			  	10	ZT1224300057000	SOPORTE CUADRO	2
				11	ZT1224100037000	PRECINTOS 3.6X295	2
				12	ZT1274300038000	SOPORTE CANISTER	1
			  	13	ZT1250303010093	TUERCA M6	2
				14	ZT1224300086000	PASACABLE INSTALACIÓN ELECTRICA	1
				15	ZT1251100102000	BULON M6X16 (NO STD)	1
			16	ZT1224300112000	SOPORTE CABLE SENSOR ABS	1	
			17				
			18				





FIG.	NOMBRE	IMAGEN CONJUNTO	IMAGEN DE PARTES	Nº	CÓDIGO	DESCRIPCIÓN	CANT.
74	INSTALACIÓN ELECTRICA R1 350			1	ZT1184300033000	INSTALACIÓN ELECTRICA R1 350	1
				2	ZT1224300110000	PRECINTO 20X200	7
				3	ZT1184200016000	SIRENA DE UNIDAD DE LLAVES PKE	1
				4	ZT1184100017000	RELÉ INYECCIÓN ELECTRONICA COMBUSTIBLE	5
				5	ZT1180300101000	DESTELLADOR GIRO LED 350	1
				6	ZT1184200127000	FUSIBLE 10A	10
				7	ZT1184200128000	FUSIBLE 15A	7
				8	ZT1184200129000	FUSIBLE 25A	3
				9	ZT1224100030000	PRECINTO	1
				10	ZT1184200206000	FUSIBLE 1A	1
75	CERRADURA ELECTRONICA ASIENTO			1	ZT1274100058000	CERRADURA ELECTRONICA ASIENTO	1
				2	ZT1251100101000	BULON M6X12 (NO STD)	3
				3	ZT1224200205000	SOPORTE TRABA ASIENTO	1
				4	ZT1184200004000	BOCINA	1
				5	ZT1050954009000	ELECTROVALVULA TANQUE FILTRO COMBUSTIBLE	1
				6	ZT1250303010093	TUERCA M6	1
				7	ZT1251112001093	BULON M6X16	1
				8			







FIG.	NOMBRE	IMAGEN CONJUNTO	IMAGEN DE PARTES	Nº	CÓDIGO	DESCRIPCIÓN	CANT.
76	REGULADOR TENSIÓN (350W)			1	ZT1184300013000	REGULADOR TENSIÓN (350W)	1
				2	ZT1251100061093	BULON M6X22	4
				3	ZT1050958006000	BOBINA EXTERNA	1
				4	ZT1050958007000	CABLE BOBINA EXTERNA	1
				5	ZT1050958004000	BUJIA 350	1
				6			
				7			
				8			
77	UNIDAD PKE 350			1	ZT1184300024100	UNIDAD PKE 350	1
				2	ZT1251100102000	BULON M6X16 (NO STD)	2
				3	ZT1274100057095	BUJE 6.2X8.5X3.5 + 14X1.5	2
				4	ZT1244100052000	ARANDELA GOMA 8.5X14X1	2
				5	ZT1270300273000	PASACABLE FLEX. L=73	1
				6	ZT1184200092000	COMANDO LLAVE - (COPIA)	1
				7	ZT1184200053000	ANTENA UNICA EXTERNA	1
				8	ZT1184300005000	ANTENA TRASERA	2
				9	ZT1184200182000	PILA LLAVE ALARMA (BAND)	2
				10	ZT1244200100000	O-RING DE COMANDO LLAVE	1











FIG.	NOMBRE	IMAGEN CONJUNTO	IMAGEN DE PARTES	Nº	CÓDIGO	DESCRIPCIÓN	CANT.		
78	INTERRUPTOR DE MOTOR					1	ZT1184100012000	INTERRUPTOR DE MOTOR	1
						2	ZT1250205040095	BULON M8X16	2
						3	ZT1274100017000	PASACABLE DE INSTALACIÓN ELECTRICA	2
			4	ZT1274100095000	PASACABLE DE INTERRUPTOR	1			
			5	ZT1224100037000	PRECINTOS 3.6X295	1			
			6						
			7						
			8						
			9						
79	SOPORTE FRONTAL MOTOR					1	ZT4024300003021	SOPORTE FRONTAL MOTOR	1
						2	ZT1251112019000	BULON M12X85X1.25	2
						3	ZT1250305009091	TUERCA M12X1.25	2
			4	ZT1274300082000	SOPORTE SUP. MOTOR	2			
			5	ZT1251100132003	BULON M10X1.5X80	2			
			6	ZT1251300057093	TUERCA M10X1.5	2			
			7						
			8						
			9						







FIG.	NOMBRE	IMAGEN CONJUNTO	IMAGEN DE PARTES	Nº	CÓDIGO	DESCRIPCIÓN	CANT.
80	PLACA MONTAJE CALIPER TRAS. TITANIO			1	ZT1271200165000	SOSTEN LATERAL GRIS	1
				2	ZT1251100088094	BULON M10x1.5x43	1
				3	ZT1264100001000	RESORTE SOSTEN LATERAL	1
				4	ZT1251700025091	BUJE DE SOSTEN LATERAL	1
				5	ZT1251300057093	TUERCA M10X1.5	1
				6			
			7				
			8				
			9				
81	PLACA MONTAJE CALIPER TRAS. GRIS			1	ZT1224300002000	CAJA FILTRO AIRE 350	1
				2	ZT1251300063093	GRAMPA M6X11X15	6
				3	ZT1251100101000	BULON M6X12 (NO STD)	6
				4	ZT1050961004000	SENSOR TEMPERATURA AIRE DE ADMISION	1
				5	ZT1224300069000	CANISTER 350	1
				6	ZT1050958015000	TUBO DESORCIÓN DEL ACELERADOR	1
			7	ZT4134300003000	FILTRO DE AIRE 350	1	
			8	ZT1051371002000	ABRAZADERA 59X9 CUERPO INYECTOR	1	
			9	ZT1224300110000	PRECINTO 20X200	1	







FIG.	NOMBRE	IMAGEN CONJUNTO	IMAGEN DE PARTES	Nº	CÓDIGO	DESCRIPCIÓN	CANT.
82	CUERPO INYECTOR		 	1	ZT1050958001000	CUERPO INYECTOR 350	1
				2	ZT1050958003000	ACOPLE CUERPO INYECTOR	1
				3	ZT1051354004000	ABRAZADERA 56X10	1
				4	ZT1051454016000	O'RING 45X2,5	1
				5	ZT1251100061093	BULON M6X22	2
				6	ZT1050954025000	MOTOR PASO A PASO 8MM	1
				7			
				8			
				9			
83	SENSOR PRESIÓN DE ADMISIÓN		  	1	ZT1050961003000	SENSOR PRESIÓN DE ADMISIÓN	1
				2	ZT1050958008000	TUBO SENSOR PRESIÓN ADMISIÓN	1
				3	ZT1250106112000	BULON M5X20 CON GROWER	1
				4	ZT1050958009000	SOPORTE SENSOR PRESIÓN DE ADMISIÓN	1
				5	ZT1251100061093	BULON M6X22	1
				6	ZT1050954023000	INYECTOR COMBUSTIBLE	1
				7	ZT1050970002000	CAPUCHON DE INYECTOR	1
				8			
				9			







FIG.	NOMBRE	IMAGEN CONJUNTO	IMAGEN DE PARTES			Nº	CÓDIGO	DESCRIPCIÓN	CANT.
84	MOTOR COMPLETO					1	ZT5580101001051	MOTOR COMPLETO 350 GRIS	1
						2	ZT1051354008000	SOPORTE CABLE EMBRAGUE-MOTOR	1
						3			
						4			
						5			
						6			
						7			
						8			
						9			
85	TAPA CUBRE PIÑON GRIS					1	ZT4050854002051	TAPA CUBRE PIÑON GRIS	1
						2	ZT1251112003093	BULON M6X45	2
						3			
						4			
						5			
						6			
						7			
						8			
						9			









































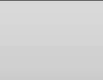







FIG.	NOMBRE	IMAGEN CONJUNTO	IMAGEN DE PARTES			Nº	CÓDIGO	DESCRIPCIÓN	CANT.
86	SALIDA ESCAPE CON CATALIZADOR					1	ZT4084300012000	SALIDA ESCAPE CON CATALIZADOR E5 350	1
						2	ZT1070100499000	JUNTA DE ESCAPE 350	1
						3	ZT1251300058093	TUECA M8 TUBO SALIDA ESCAPE	2
						4	ZT1020243097000	BUJE DISTANCIADOR SALIDA DE ESCAPE	2
						5	ZT1244300022000	SILENT-BLOCK SILENCIADOR	2
						6	ZT1020243098000	ARANDELA SALIDA DE ESCAPE	1
						7	ZT1250205125000	BULON M8X35 ALLEN	2
						8	ZT1124300004000	JUNTA GRAFITO SILENCIADOR 37.8X28X11	1
						9	ZT1050970011000	SONDA LAMBDA (L=635)	1
87	SILENCIADOR					1	ZT4084300011051	SILENCIADOR 350 GRIS	1
						2	ZT1274100074000	ABRAZADERA SILENCIADOR	1
						3	ZT1250205023000	BULON M8X35 ALLEN	1
						4	ZT4084300010051	PROTECTOR SILENCIADOR GRIS 350	1
						5	ZT1250501010000	GROWER 6	3
						6	ZT1251100101000	BULON M6X12 (NO STD)	3
						7	ZT1020243097000	BUJE DISTANCIADOR SALIDA DE ESCAPE	1
						8	ZT1244300022000	SILENT-BLOCK SILENCIADOR	1
						9	ZT1250205125000	BULON M8X35 ALLEN	1









FIG.	NOMBRE	IMAGEN CONJUNTO	IMAGEN DE PARTES	Nº	CÓDIGO	DESCRIPCIÓN	CANT.
88	SOPORTE PEDALIN IZQ.		  	1	ZT4064300022051	SOPORTE PEDALIN IZQ. GRIS 350	1
				2	ZT1250205023000	BULON M8X35 ALLEN	2
					ZT1250205034093	BULON M8X16	1
				3	ZT1244100002000	SILENT-BLOCK CACHAS TANQUE	2
				4	ZT4064300011051	PEDALIN ACOMP. IZQ. GRIS 350	1
				5	ZT1260100301000	RESORTE ESFERA POSICIÓN PEDALIN	1
				6	ZT1274300031000	ESFERA POSICIÓN PEDALIN ACOMPAÑANTE	1
				7	ZT1274300032000	PLACA POSICIÓN PEDALIN	1
				8	ZT1274300033000	PERNO PEDALIN	1
				9	ZT1264100006000	SEGUER E	1
10	ZT1244100052000	ARANDELA GOMA 8.5X14X1	1				
89	PEDALIN CONDUCTOR IZQ.		  	1	ZT4064300009051	PEDALIN CONDUCTOR IZQ. GRIS 350	1
				2	ZT1264100003000	RESORTE PEDALIN IZQUIERDO	1
				3	ZT1274300033000	PERNO PEDALIN	1
				4	ZT1264100006000	SEGUER E	1
				5	ZT1244100052000	ARANDELA GOMA 8.5X14X1	1
				6			
				7			









FIG.	NOMBRE	IMAGEN CONJUNTO	IMAGEN DE PARTES	Nº	CÓDIGO	DESCRIPCIÓN	CANT.
90	SOPORTE DE CANDADO		  	1	ZT1274200037000	SOPORTE DE CANDADO	1
				2	ZT1251100101000	BULON M6X12 (NO STD)	1
				3	ZT1251100102000	BULON M6X16 (NO STD)	1
				4			
				5			
				6			
				7			
				8			
				9			
91	LEVA COMANDO DE CAMBIOS GRIS		  	10	ZT1271200163000	LEVA COMANDO DE CAMBIOS GRIS	1
				2	ZT1251100061093	BULON M6X22	3
				3	ZT1250303010093	TUERCA M6	2
				4	ZT1274100042000	ROTULA LEVA COMANDO DE CAMBIO	1
				5	ZT1250301020093	TUERCA M6	1
				6	ZT1274300026000	VARILLA PALANCA CAMBIO 350	1
				7	ZT1274100043000	ROTULA PALANCA CAMBIOS	1
				8	ZT1250301018093	TUERCA M6 - ROSCA IZQ	1
				9			





FIG.	NOMBRE	IMAGEN CONJUNTO	IMAGEN DE PARTES	Nº	CÓDIGO	DESCRIPCIÓN	CANT.
92	PALANCA CAMBIO			1	ZT4024300029000	PALANCA CAMBIO GRIS 350	1
				2	ZT1274300027000	CUBRE RODAMIENTO PEDAL FRENO/CAMBIO	1
				3	ZT1250205124000	BULON M8X30 ESP.	1
				4	ZT1274300028000	PERNO APOYA PIE PALANCA CAMBIO	1
				5	ZT1244100031000	GOMA APOYA PIE PALANCA CAMBIO	1
				6	ZT1250301033000	TUERCA M8	1
				7	ZT1251300094000	TUERCA M8 ESPECIAL	1
				8	ZT1250401011093	CHAVETA 2X15	1
93	SOPORTE PEDALIN DER.			1	ZT4064300021051	SOPORTE PEDALIN DER. GRIS 350	1
				2	ZT1250205023000	BULON M8X35 ALLEN	2
					ZT1250205034093	BULON M8X16	1
				3	ZT1244100002000	SILENT-BLOCK CACHAS TANQUE	3
				4	ZT4064300012051	PEDALIN ACOMP. DER. GRIS 350	1
				5	ZT1260100301000	RESORTE ESFERA POSICIÓN PEDALIN	1
				6	ZT1274300031000	ESFERA POSICIÓN PEDALIN ACOMPAÑANTE	1
				7	ZT1274300032000	PLACA POSICIÓN PEDALIN	1
				8	ZT1274300033000	PERNO PEDALIN	1
				9	ZT1244300039000	PROTECTOR SILICONA DE SALIDA ESCAPE	2
				10	ZT1244100052000	ARANDELA GOMA 8.5X14X1	1
11	ZT1244300039000	PROTECTOR SILICONA DE SALIDA ESCAPE	1				





FIG.	NOMBRE	IMAGEN CONJUNTO	IMAGEN DE PARTES	Nº	CÓDIGO	DESCRIPCIÓN	CANT.
94	SOPORTE RESORTE PEDAL FRENO (KIT)			1	ZT1250900302000	SOPORTE RESORTE PEDAL FRENO (KIT)	1
				2	ZT1250301023093	TUERCA M5	1
				3			
				4			
				5			
				6			
				7			
				8			
				9			
95	PEDALIN CONDUCTOR DER.			1	ZT4064300010051	PEDALIN CONDUCTOR DER. GRIS 350	1
				2	ZT1264100004000	RESORTE PEDALIN DERECHO	1
				3	ZT1274300033000	PERNO PEDALIN	1
				4	ZT1264100006000	SEGUER E	1
				5	ZT1244100052000	ARANDELA GOMA 8.5X14X1	1
				6			
				7			
				8			
				9			



FIG.	NOMBRE	IMAGEN CONJUNTO	IMAGEN DE PARTES	Nº	CÓDIGO	DESCRIPCIÓN	CANT.
96	SOPORTE PEDAL FRENO TRAS.			1	ZT4024300028000	SOPORTE PEDAL FRENO TRAS.	1
				2	ZT1260100303000	RESORTE PEDAL FRENO TRAS.	1
				3	ZT1274300027000	CUBRE RODAMIENTO PEDAL FRENO/CAMBIO	1
				4	ZT1250205124000	BULON M8X30 ESP.	1
				5	ZT1274300019000	PEDAL FRENO TRASERO 350	1
				6	ZT1251112001093	BULON M6X16	3
				7			
				8			
				9			
97	PROTECTOR BOMBA FRENO TRAS.			1	ZT1224300023000	PROTECTOR BOMBA FRENO TRAS.	1
				2	ZT1251100101000	BULON M6X12 (NO STD)	3
				3	ZT1244100052000	ARANDELA GOMA 8.5X14X1	3
				4	ZT1274100057095	BUJE 6.2X8.5X3.5 + 14X1.5	3
				5			
				6			
				7			
				8			
				9			

FIG.	NOMBRE	IMAGEN CONJUNTO	IMAGEN DE PARTES	Nº	CÓDIGO	DESCRIPCIÓN	CANT.
98	PROTECTOR CALOR SILENCIADOR			1	ZT1020443011000	PROTECTOR CALOR SILENCIADOR	1
				2			
				3			
				4			
				5			
				6			
				7			
				8			
				9			
99	GOMA PEDALIN POSAPIE			1	ZT1244300013000	GOMA PEDALIN POSAPIE	4
				2	ZT1274300093000	PLACA SOPORTE GOMA PEDALIN	4
				3	ZT1251100167000	BULON M6X8	2
				4	ZT1250205038000	BULON M5X12	4
				5	ZT4064300005051	SOPORTE PEDALIN ACOMPAÑANTE DER T350 GRIS	1
				6	ZT4064300006051	SOPORTE PEDALIN ACOMPAÑANTE IZQ T350 GRIS	1
				7	ZT4064300007051	SOPORTE PEDALIN CONDUCTOR IZQ T350 GRIS	1
				8	ZT4064300008051	SOPORTE PEDALIN CONDUCTOR DER T350 GRIS	1
				9	ZT1250501010000	GROWER 6	4



FIG.	NOMBRE	IMAGEN CONJUNTO	IMAGEN DE PARTES	Nº	CÓDIGO	DESCRIPCIÓN	CANT.
100	RADIADOR IZQUIERDO		  	1	ZT1274300023000	RADIADOR IZQUIERDO 350	1
				2	ZT1274300024000	RADIADOR DERECHO 350	1
				3	ZT1244200011000	TUBO CONEXIÓN ENTRE RADIADORES	1
			  	4	ZT1274200090000	ABRAZADERA CLIP	2
				5	ZT1244100002000	SILENT-BLOCK CACHAS TANQUE	4
				6	ZT1251100061093	BULON M6X22	5
				7	ZT1276200043000	ABRAZADERA FLEXIBLE 57MM	2
				8	ZT1224300085000	SEGURO CLIP	1
				9			
101	TAPA RADIADOR		  	1	ZT1224300020000	TAPA RADIADOR	1
				2	ZT1274300025000	SOPORTE TAPA RADIADOR	1
				3	ZT1244300009000	TUBO TAPA RADIADOR	1
			  	4	ZT1274200089000	ABRAZADERA CLIP 22	2
				5	ZT1250104006097	BULON M6X12	1
				6	ZT1251100101000	BULON M6X12 (NO STD)	1
			7				
			8				
			9				









FIG.	NOMBRE	IMAGEN CONJUNTO	IMAGEN DE PARTES			Nº	CÓDIGO	DESCRIPCIÓN	CANT.
102	TANQUE AGUA AUXILIAR					1	ZT1224300019000	TANQUE AGUA AUXILIAR	1
						2	ZT1244300010000	TUBO CONEXIÓN DE TANQUE AGUA-RADIADOR	1
						3	ZT1274200088000	ABRAZADERA CLIP 10.5	2
			4	ZT1274200079000	ABRAZADERA CLIP 9	1			
			5	ZT1244200025000	TUBO DRENAJE TANQUE AGUA	1			
			6	ZT1251100061093	BULON M6X22	1			
			7	ZT1224300050000	ABRAZADERA TUBOS TANQUE AGUA	1			
			8						
			9						
103	TUBO SALIDA AGUA DE MOTOR					1	ZT1244200001000	TUBO SALIDA AGUA DE MOTOR	1
						2	ZT1274200019000	TERMOSTATO	1
						3	ZT1244200010000	TUBO ENTRADA AGUA DE RADIADOR IZQUIERDO	1
			4	ZT1244200021000	TUBO AGUA CHICO DE CIRCUITO DE REFRIGERACIÓN	1			
			5	ZT1274200089000	ABRAZADERA CLIP 22	1			
			6	ZT1274200090000	ABRAZADERA CLIP	3			
			7	ZT1274200091000	ABRAZADERA CLIP 27	2			
			8						
			9						







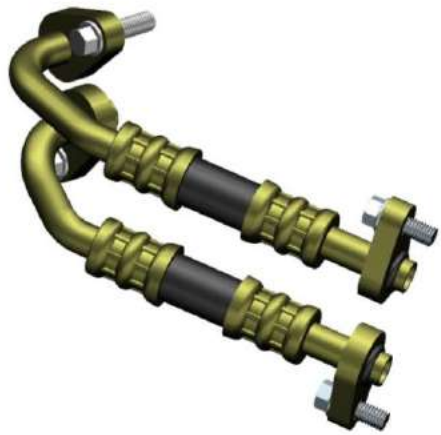

FIG.	NOMBRE	IMAGEN CONJUNTO	IMAGEN DE PARTES	Nº	CÓDIGO	DESCRIPCIÓN	CANT.
104	TUBO ENTRADA DE AGUA DE MOTOR			1	ZT1244200098000	TUBO ENTRADA DE AGUA DE MOTOR (V2)	1
				2	ZT1244200012000	TUBO AGUA DE MOTOR	1
				3	ZT1274200090000	ABRAZADERA CLIP	1
				4	ZT1274200041000	ABRAZADERA MAGUERA MOTOR	3
				5			
				6			
				7			
				8			
				9			
105	RADIADOR DE ACEITE			1	ZT1274300022000	RADIADOR DE ACEITE	1
				2	ZT1274300036000	SOPORTE SUP. RADIADOR ACEITE	1
				3	ZT1274300037000	SOPORTE INF. RADIADOR ACEITE	1
				4	ZT1251112001093	BULON M6X16	3
				5	ZT1251112002093	BULON M6X30	1
				6	ZT1251100061093	BULON M6X22	1
				7			
				8			
				9			



FIG.	NOMBRE	IMAGEN CONJUNTO	IMAGEN DE PARTES	Nº	CÓDIGO	DESCRIPCIÓN	CANT.
106	TUBO ENTRADA ACEITE DE MOTOR			1	ZT1244300008000	TUBO ENTRADA ACEITE DE MOTOR	1
				2	ZT1244300007000	TUBO SALIDA ACEITE DE MOTOR	1
				3	ZT1251100061093	BULON M6X22	2
				4	ZT1251112001093	BULON M6X16	2
				5	ZT1051454025000	O-RING 9.8X2.4 NITRILO	4
				6			
				7			
				8			
				9			

CATÁLOGO DE PIEZAS DE REPUESTO

**ZONTES** | 350 *EURO5*

**MOTOR**

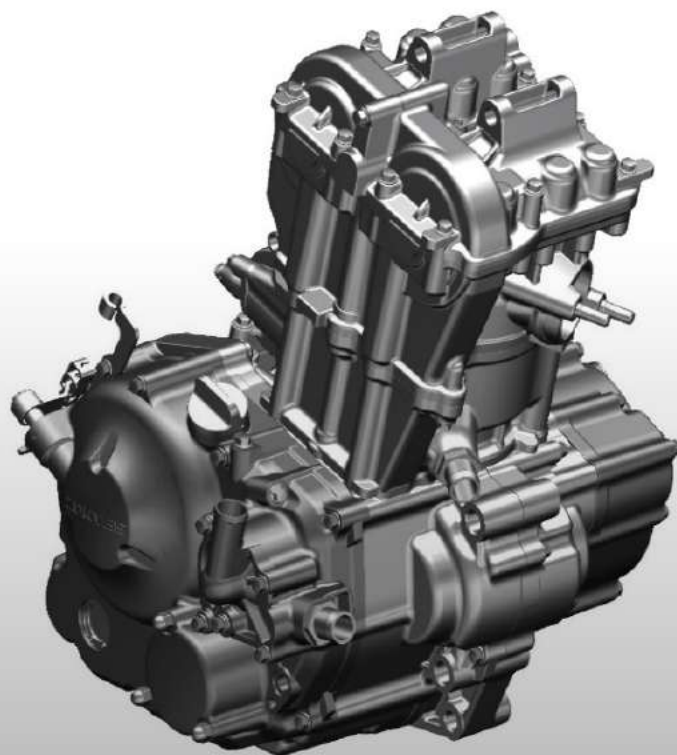

FIG.	NOMBRE	IMAGEN CONJUNTO	IMAGEN DE PARTES	Nº	CÓDIGO	DESCRIPCIÓN	CANT.
1	TAPA CILINDRO COMPLETA			1	ZT4050658004000	TAPA CILINDRO COMPLETA	1
				2	ZT1050153005000	RETÉN TAPA DE CILINDRO	2
				3	ZT1251112024000	BULON M8X117	2
				4	ZT1251401003000	BUJE POSICIONADOR 10X14	1
					ZT1251401001000	BUJE POSICIONADOR 8X14	2
				5	ZT1051454027000	O-RING 7.5X1.5	1
				6	ZT1251300052094	TUERCA CIEGA M6X9	4
				7	ZT1251500041000	ARANDELA 10.3X20X2	4
				8	ZT1051658001000	JUNTA TAPA CILINDRO	1
9	ZT1051658002000	JUNTA TAPA VÁLVULAS	1				
2	TAPA CILINDRO ARBOL LEVAS			1	ZT4050658008000	TAPA CILINDRO C/ARBOL LEVAS	1
				2	ZT1050958004000	BUJIA 350	1
				3	ZT1051454007000	19x2.65 EPDM O-RING	1
				4	ZT1051954001000	TUBO SALIDA ACEITE TAPA CILINDRO	1
				5	ZT1251112001093	BULON M6X16	2
				6	ZT1051454009000	O-RING 9X2	1
				7	ZT1050954003000	SENSOR ACEITE Y AGUA + O-RING	1
				8			

FIG.	NOMBRE	IMAGEN CONJUNTO	IMAGEN DE PARTES	Nº	CÓDIGO	DESCRIPCIÓN	CANT.
3	TAPA CILINDRO VALVULAS			1	ZT4050658009000	TAPA CILINDRO C/VALVULAS	1
				2	ZT1050154020000	PASTILLAS REGULACIÓN VÁLVULAS 8.85	4
				3	ZT1050158009000	3X27X19 SLIDELIFTER	4
				4	ZT4051758008000	ARBOL LEVAS ADMISIÓN	1
				5	ZT4051758009000	ARBOL LEVAS ESCAPE	1
				6			
4	TAPA CILINDRO			1	ZT4050658005000	TAPA CILINDRO	1
				2	ZT1050153015000	APOLLO RESORTE VALVULA	4
				3	ZT1051553001000	RETÉN VALVULA 5.0	4
				4	ZT1050158006000	VÁLVULA ADMISIÓN	2
				5	ZT1050158007000	VÁLVULA ESCAPE	2
				6	ZT1050158001000	RESORTE VÁLVULA ADMISIÓN	4
				7	ZT1050154039000	RESORTE VÁLVULA ESCAPE	4
				8	ZT1050154016000	PLATILLO RESORTE VALVULA	4
				9	ZT1050158008000	SEGURO DE VÁLVULA	8
				10	ZT1251111011000	ESPARRAGO M8X38	2
				11	ZT1251112003093	BULON M6X45	12
				12	ZT1251401001000	BUJE POSICIONADOR 8X14	10

FIG.	NOMBRE	IMAGEN CONJUNTO	IMAGEN DE PARTES	Nº	CÓDIGO	DESCRIPCIÓN	CANT.
5	TAPA DE VÁLVULAS			1	ZT4050758001000	TAPA DE VÁLVULAS	1
				2	ZT1050154034000	PLACA CADENA DISTRIBUCIÓN (9 MM)	1
				3	ZT1251513001019	ARANDELA 6.3X12X1.6 COBRE	1
				4	ZT1251100067093	BULON M6X10	1
				5	ZT1250205023000	BULON M8X35 ALLEN	1
				6	ZT1251112003093	BULON M6X45	2
				7	ZT1251112002093	BULON M6X30	8
				8	ZT1051658002000	JUNTA TAPA VÁLVULAS	1
				9			
6	CILINDRO			1	ZT4050558003000	CILINDRO COMPLETO 350	1
				2	ZT1051658001000	JUNTA TAPA CILINDRO	1
				3	ZT1051658007000	JUNTA BASE CILINDRO	1
				4	ZT1251112002093	BULON M6X30	1
				5	ZT1051301052000	BUJE POSICIONADOR 12X20	2
				6	ZT1251401001000	BUJE POSICIONADOR 8X14	1
				7	ZT1051161003000	BUJE POSICIONADOR 9X14	1
				8	ZT1244200012000	TUBO AGUA DE MOTOR	1
				9	ZT1274200041000	ABRAZADERA MAGUERA MOTOR	2





FIG.	NOMBRE	IMAGEN CONJUNTO	IMAGEN DE PARTES	Nº	CÓDIGO	DESCRIPCIÓN	CANT.
7	CILINDRO			1	ZT4050558004000	CILINDRO 350	1
				2	ZT1050458008000	PISTON COMPLETO 350	1
				3			
				4			
				5			
				6			
				7			
				8			
				9			
8	CILINDRO SOLO			1	ZT4050558001000	CILINDRO SOLO	1
				2	ZT1051954017000	TUBO ENTRADA Y SALIDA AGUA	1
				3	ZT1051454008000	O-RING 19X1.5	1
				4			
				5			
				6			
				7			
				8			
				9			

FIG.	NOMBRE	IMAGEN CONJUNTO	IMAGEN DE PARTES	Nº	CÓDIGO	DESCRIPCIÓN	CANT.
9	PISTON			1	ZT1050458001000	PISTON 350	1
				2	ZT1050458003000	ARO 1° COMPRESIÓN	1
				3	ZT1050458004000	ARO 2° COMPRESIÓN	1
				4	ZT1050458005000	AROS DE ACEITE	1
				5	ZT1050458002000	PERNO PISTON	1
				6	ZT1050454007000	SEGURO PISTÓN 21X1.2	1
				7			
				8			
				9			
10	EMBRAGUE COMPLETO			1	ZT4051658014000	EMBRAGUE COMPLETO (8 DISCOS)	
				2	ZT1050754006000	EJE LEVA DE EMBRAGUE	1
				3	ZT1251311001094	TUERCA M16X1	1
				4	ZT125151402000	ARANDELA 16.2X28X2.4X2	1
				5	ZT1251512011000	ARANDELA 16.2X30X1	1
				6	ZT1250602014000	RODAMIENTO AGUJA K27X32X29.3	1
				7	ZT1050753010000	ARANDELA EMPUJE BUJE EMBRAGUE	1
				8	ZT1050753022000	BUJE EMBRAGUE	1
				9			

FIG.	NOMBRE	IMAGEN CONJUNTO	IMAGEN DE PARTES	Nº	CÓDIGO	DESCRIPCIÓN	CANT.
11	EMBRAGUE			1	ZT4051058006000	CONJUNTO DISCOS EMBRAGUE	1
				2	ZT1050758006000	CANASTA PORTA DISCOS EMBRAGUE	1
				3	ZT1251512022000	ARANDELA 22.2X37X2	1
				4			
				5			
				6			
				7			
12	EMBRAGUE			1	ZT1251512031000	ARANDELA 96.3X107X1	1
				2	ZT1251514006000	ARANDELA ANTIVIBRACIÓN 10.3X28X2.4X2	1
				3	ZT1050753012000	SEPARADOR DISCO EMBRAGUE	1
				4	ZT1050754022000	SEPARADOR DISCOS EMBRAGUE	1
				5	ZT1051454017000	SILENT-BLOCK DE EMBRAGUE	3
				6	ZT1050758002000	RESORTE EMBRAGUE	3
				7	ZT1050754007000	PLACA FIJ. RESORTE EMBRAGUE	1
				8	ZT1251100070093	BULON M6X30	3
				9	ZT1050758007000	DISCOS DE EMBRAGUE KIT	1
				10	ZT4051058004000	PLACA EXTERIOR EMBRAGUE (8 DISCOS)	1
				11	ZT4051058007000	PLACA DE PRESION EMBRAGUE (8 DISCOS)	1







FIG.	NOMBRE	IMAGEN CONJUNTO	IMAGEN DE PARTES	Nº	CÓDIGO	DESCRIPCIÓN	CANT.
13	CAJA CAMBIOS		 	1	ZT4051758010000	ARBOL PRIMARIO COMPLETO	1
				2	ZT4051758012000	ARBOL SECUNDARIO COMPLETO	1
				3			
				4			
				5			
				6			
				7			
				8			
				9			
14	PIÑÓN		  	1	ZT1050354023000	PIÑÓN Z14 CON GOMA	1
				2	ZT1251300066093	TUERCA M18X1.0X9	1
				3	ZT1051354002000	ARANDELA PIÑON Z14	1
				4	ZT1050254001000	BUJE PIÑON	1
				5	ZT1051454019000	O-RING 22.5X2.5 V	2
				6			
				7			
				8			
				9			

FIG.	NOMBRE	IMAGEN CONJUNTO	IMAGEN DE PARTES	Nº	CÓDIGO	DESCRIPCIÓN	CANT.
15	PLACA SELECTORA			1	ZT1050658002000	SELECTORA	1
				2	ZT1050658003000	BUJE DE SELECTORA	1
				3	ZT1050658006000	EJE PALANCA CAMBIO	1
				4	ZT1250404003000	PERNO 9.2X3X10	1
				5	ZT1050654002000	HORQUILLA SELECTORA IZQ	1
				6	ZT1050654004000	HORQUILLA SELECTORA CENTRO	1
				7	ZT1050654003000	HORQUILLA SELECTORA DER	1
				8	ZT1050653007000	EJE HORQUILLAS SELECTORA	1
				9	ZT1251100068093	BULON M6X14 - 9X2.6	1
				10	ZT1251512001000	ARANDELA 6.2X15X1	1
				11	ZT1050654008000	RESORTE TORSIÓN LEVA SELECTORA	1
				12	ZT1050653002000	LEVA DE SELECTORA	1
				13	ZT1251112002093	BULON M6X30	1
				14	ZT1050654007000	PERNO RESORTE DE PLACA SELECTORA	1
				15	ZT1050658001000	PLACA SELECTORA V	1
				16			
				17			
				18			

FIG.	NOMBRE	IMAGEN CONJUNTO	IMAGEN DE PARTES	Nº	CÓDIGO	DESCRIPCIÓN	CANT.
16	SEMICARTER IZQUIERDO			1	ZT4050158002000	SEMICARTER IZQUIERDO C/CIGÜEÑAL	1
				2	ZT1051658004000	JUNTA CARTER	1
				3	ZT1051358011000	PLACA PRESIÓN SENSOR CAMBIOS	1
				4	ZT1251100067093	BULON M6X10	2
				5	ZT1050654005000	INTERRUPTOR ENGRANAJE - SENSOR CAMBIOS	1
				6	ZT1051454019000	O-RING 22.5X2.5 V	1
				7	ZT1250201034093	BULON M5X16	2
				8	ZT1050858005000	PERNO PASADOR ACEITE 1.2X6X12	2
				9			
				10	ZT1051461008000	O-RING 4.5X1 NITRILO	4
				11	ZT1251112002093	BULON M6X30	3
				12	ZT1251112005093	BULON M6X75	8
				13	ZT1251112006093	BULON M6X90	2
				14	ZT1251401001000	BUJE POSICIONADOR 8X14	2
				15			
				16			
				17			
				18			

FIG.	NOMBRE	IMAGEN CONJUNTO	IMAGEN DE PARTES	Nº	CÓDIGO	DESCRIPCIÓN	CANT.
17	SEMICARTER IZQUIERDO			1	ZT4050158003000	SEMICARTER IZQUIERDO C/RODAMIENTOS	1
				2	ZT1051354003000	PASADOR FIJO AXLE TREE	2
				3	ZT1251100066093	TAPÓN DRENAJE ACEITE M12X1.5X15	1
				4	ZT1251400002000	BULON ESP. M10X1.25	1
				5	ZT1051354001000	SEGURO RETÉN ARBOL SECUNDARIO	1
				6	ZT1251100067093	BULON M6X10	4
				7	ZT1244100033000	JUNTA 12X20X2	1
				8	ZT1251513004019	ARANDELA COBRE 10.3X20X2	1
				9			
1							
2							
3							
4							
5							
6							
7							
8							
9							

FIG.	NOMBRE	IMAGEN CONJUNTO	IMAGEN DE PARTES	Nº	CÓDIGO	DESCRIPCIÓN	CANT.
18	SEMICARTER IZQUIERDO			1			1
				2	ZT1051161008000	CODO 16 AGUA-AIRE	1
				3	ZT1250601036000	RODAMIENTO 6202RS/P6 (NITRURACIÓN)	1
				4	ZT1050558003000	RODAMIENTO 63/22/P53	1
				5	ZT1250601056000	RODAMIENTO 63/23RS/P5 (NITRURACIÓN)	1
				6	ZT1050658004000	RODAMIENTO 6804P 63	1
				7	ZT1250602022000	RODAMIENTO AGUJA HK1010	1
				8	ZT1051554002000	RETÉN 30X42X7	1
				9	ZT1051561002000	RETÉN 14X25X7	1
				10	ZT1051353014000	BUJE TRASERO CARTER DERECHO	1
				11	ZT1050853020000	BUJE ACEITE 8X7.5	2
				12	ZT1251111005094	ESPARRAGO CILINDRO M10X1.25X168	2
				13	ZT1050558005000	RODAMIENTO 56X22X15 CS	1
				14			
				15			
				16			
				17			
				18			

FIG.	NOMBRE	IMAGEN CONJUNTO	IMAGEN DE PARTES	Nº	CÓDIGO	DESCRIPCIÓN	CANT.
19	CIGÜEÑAL COMPLETO			1	ZT4051758007000	CIGÜEÑAL	1
				2	ZT4051758006000	BALANCEADOR	1
				3	ZT1050454017000	ARANDELA DER. CIGÜEÑAL	1
				4	ZT1050154041000	CONTRAPESO	1
				5	ZT1251802004000	CHAVETA 5X5.5X26X9	1
				6	ZT1050358005000	ENGRANAJE PRIMARIO	1
				7	ZT1050358007000	ENGRANAJE BOMBA AGUA-CIGÜEÑAL	1
				8	ZT1251801003000	CHAVETA RECTANGULAR 5X5.5X19.2	1
				9	ZT1251514003000	ARANDELA ANTIVIBRACIÓN 18.2X28X2.4X2	1
				10	ZT1251311002094	TUERCA M18X1.0X10	1
				11	ZT1251802003000	CHAVETA 4X4.6X25X14	1
				12			
				13			
				14			
				15			
				16			
				17			
				18			

FIG.	NOMBRE	IMAGEN CONJUNTO	IMAGEN DE PARTES	Nº	CÓDIGO	DESCRIPCIÓN	CANT.
20	SEMICARTER DERECHO			1	ZT4050258002000	SEMICARTER DERECHO COMPLETO	1
				2	ZT1050858003000	BOMBA DE ACEITE	1
				3	ZT1051658006000	JUNTA BOMBA DE ACEITE	1
				4	ZT1050358008000	ENGRANAJE BOMBA ACEITE	1
				5	ZT1250404006000	PERNO 9.2X5X18	1
				6	ZT1251512007000	ARANDELA 12.2X20X1	1
				7	ZT1251401003000	BUJE POSICIONADOR 10X14	1
				8	ZT1051458002000	SELLO 9.8X15.2X2.7	1
				9	ZT1251401001000	BUJE POSICIONADOR 8X14	2
				1	ZT1051354012000	ARANDELA 9.2 x 18 x 1	1
				2	ZT1251112002093	BULON M6X30	2
				3	ZT1251112003093	BULON M6X45	3
				4	ZT1251112006093	BULON M6X90	1
				5			
				6			
				7			
				8			
9							

FIG.	NOMBRE	IMAGEN CONJUNTO	IMAGEN DE PARTES	Nº	CÓDIGO	DESCRIPCIÓN	CANT.
21	SEMICARTER DERECHO			1	ZT4050258003000	SEMICARTER DERECHO C/RODAMIENTOS	1
				2	ZT1050158004000	PATIN TENSOR CADENA DISTRIBUCIÓN	1
				3	ZT1251100168093	BULON M6X15	1
				4	ZT1251512001000	ARANDELA 6.2X15X1	2
				5	ZT1050653002000	LEVA DE SELECTORA	1
				6	ZT1050654008000	RESORTE TORSIÓN LEVA SELECTORA	1
				7	ZT1251100068093	BULON M6X14 - 9X2.6	1
				8	ZT1051353006000	PLACA RODAMIENTO EJE CIGÜEÑAL	1
				9	ZT1251112001093	BULON M6X16	2
				10	ZT1050858001000	COLADOR ACEITE 75.7X53.2	1
				11	ZT1050858008000	TRAMPA DE ACEITE	1
				12	ZT1051458004000	O-RING TRAMPA ACEITE	1
				13	ZT1251100061093	BULON M6X22	2
				14			
				15			
				16			
				17			
				18			

FIG.	NOMBRE	IMAGEN CONJUNTO	IMAGEN DE PARTES	Nº	CÓDIGO	DESCRIPCIÓN	CANT.
22	SEMICARTER DERECHO			1			1
				2	ZT1050558003000	RODAMIENTO 63/22/P53	1
				3	ZT1250601052000	RODAMIENTO 62/22/P5 (NITRURACIÓN)	1
				4	ZT1250601057000	RODAMIENTO 6203/P5 (NITRURACIÓN)	1
				5	ZT1050658005000	RODAMIENTO 16004P63	1
				6	ZT1051371003000	PLACA RODAMIENTO 16004	2
				7	ZT1251100067093	BULON M6X10	2
				8	ZT1051353014000	BUJE TRASERO CARTER DERECHO	1
				9	ZT1251111005094	ESPARRAGO CILINDRO M10X1.25X168	2
				10	ZT1050853019000	TAPON ACEITE 5X7.5	3
				11	ZT1050558005000	RODAMIENTO 56X22X15 CS	1
				12			
				13			
				14			
				15			
				16			
				17			
				18			

FIG.	NOMBRE	IMAGEN CONJUNTO	IMAGEN DE PARTES	Nº	CÓDIGO	DESCRIPCIÓN	CANT.
23	TAPA IZQUIERDA CARTER			1	ZT4050358002051	TAPA IZQUIERDA CARTER COMPLETA	1
				2	ZT1051653004000	JUNTA TAPA CARTER IZQ.	1
				3	ZT4051058001051	TAPA ENGRANAJE REDUCTOR GRIS V	1
				4	ZT1051454022000	O-RING 69.3 NITRILO	1
				5	ZT4050956003051	TAPOM M30X1.5 GRIS	1
				6	ZT1051454023000	O-RING 27.4X2.665 NITRILO	1
				7	ZT1040953002093	TAPON M14X1.5	1
				8	ZT1051454024000	O-RING 13X2.8 NITRILO	1
				9	ZT1251112002093	BULON M6X30	4
				10	ZT1251112005093	BULON M6X75	7
				11	ZT1251401001000	BUJE POSICIONADOR 8X14	2
				12			
				13			
				14			
				15			
				16			
				17			
				18			





FIG.	NOMBRE	IMAGEN CONJUNTO	IMAGEN DE PARTES	Nº	CÓDIGO	DESCRIPCIÓN	CANT.
24	TAPA IZQUIERDA CARTER			1	ZT4050358003051	TAPA CARTER IZQUIERDO GRIS V	1
				2	ZT1051058001000	ESTATOR 350	1
				3	ZT1051353005000	PLACA DE PRESIÓN BOBINA MAGNETICO	1
				4	ZT1251201001094	BULON M5X15	3
				5	ZT1251201002094	BULON M6X35	3
				6			
				7			
				8			
				9			
25	TAPA ENGRANAJE REDUCTOR			1	ZT4051058002000	TAPA ENGRANAJE REDUCTOR GRIS V	1
				2	ZT1250601035000	RODAMIENTO 6201RS/P6	1
				3	ZT1051358008000	SEGURO SEGUER RODAMIENTO	1
				4			
				5			
				6			
				7			
				8			
				9			

FIG.	NOMBRE	IMAGEN CONJUNTO	IMAGEN DE PARTES	Nº	CÓDIGO	DESCRIPCIÓN	CANT.
26	TAPA DERECHA CARTER COMPLETA			1	ZT4050458005051	TAPA DERECHA CARTER COMPLETA	1
				2	ZT1051658008000	JUNTA TAPA DERECHA CARTER	1
				3	ZT1051354009000	LEVA VARILLA COMANDO EMBRAGUE	1
				4	ZT1050754018000	RESORTE VARILLA COMANDO EMBRAGUE	1
				5	ZT1050854007000	BUJE POSICIONADOR 6X6	2
				6	ZT1251401001000	BUJE POSICIONADOR 8X14	2
				7	ZT1251112003093	BULON M6X45	6
				8	ZT1251112004093	BULON M6X60	3
				9	ZT1251112005093	BULON M6X75	1
				10	ZT1251112006093	BULON M6X90	1
				11	ZT1251513001019	ARANDELA 6.3X12X1.6 COBRE	1
				12	ZT1051154004000	ARANDELA 10.2X18X1	1
				13	ZT1051154003000	SEGUER 10	1
				14			
				15			
				16			
				17			
				18			

FIG.	NOMBRE	IMAGEN CONJUNTO	IMAGEN DE PARTES	Nº	CÓDIGO	DESCRIPCIÓN	CANT.
27	TAPA DERECHA CARTER			1	ZT4050458006051	TAPA DERECHA CARTER C/RETEN	1
				2	ZT4050454015051	TAPA BOMBA AGUE A GRIS	1
				3	ZT4050454014051	TAPA FILTRO ACEITE GRIS	1
				4	ZT1051161012000	TAPON CARGA ACEITE M24X2	1
				5	ZT1051461007000	O-RING 25X3.1 TAPON CARGA ACEITE	1
				6	ZT1251300096000	TUERCA CIEGA M6 V	3
				7	ZT1050254008000	VARILLA COMANDO EMBRAGUE	1
				8	ZT1250511003000	SEGUER E 9	1
				9	ZT1051154004000	ARANDELA 10.2X18X1	1
				10	ZT4134300001000	FILTRO ACEITE 350 KIT	1
				11	ZT1051454005000	O-RING SELLO FILTRO ACEITE	1
				12	ZT1050853009000	RESORTE FILTRO ACEITE MOTOR	1
				13	ZT1051454020000	O-RING 55X2.5 NITRILO	1
				14	ZT1051454006000	O-RING TAPA BOMBA AGUA	1
				15	ZT1251401001000	BUJE POSICIONADOR 8X14	2
				16	ZT1251100067093	BULON M6X10	1
				17	ZT1251112002093	BULON M6X30	3
				18	ZT1251513001019	ARANDELA 6.3X12X1.6 COBRE	1
				19	ZT1051458001000	O-RING 6.5X2	2
				20	ZT1051358001000	ARANDELA COBRE 7.3X15X1.6	2
				21	ZT1251100317000	BULON PIVOT M7X12.5	2
				22	ZT1051358007000	ASIENTO RESORTE VALVULA ALIVIO	1
				23	ZT1050858006000	RESORTE VALVULA ALIVIO	1
				24	ZT1050858007000	EMBOLO VALVULA DE ALIVIO	1
				25	ZT1051358006000	SEGUER 15	1
				26	ZT1051761005000	TUBO COBRE 3X5X23	1
				27	ZT1051958003000	MANGUERA 4X7X200	1

FIG.	NOMBRE	IMAGEN CONJUNTO	IMAGEN DE PARTES	Nº	CÓDIGO	DESCRIPCIÓN	CANT.
28	TAPA DERECHA CARTER			1	ZT4050458003000	TAPA CARTER DERECHO SOLA GRIS	1
				2	ZT1250602033000	RODAMIENTO AGUJA HK1412	1
				3	ZT1250602022000	RODAMIENTO AGUJA HK1010	1
				4	ZT1051554004000	RETÉN 12X23X7	1
				5	ZT1051570007000	RETÉN 12X24X5 NITRILO	1
				6	ZT1051554001000	RETÉN 12X24X5	1
				7	ZT1051553002000	RETEN DE ACEITE FB 14X22X5 (NITRILO HIDROGENADO)	1
				8	ZT1051361002000	SEGUER 30X1.2	1
				9	ZT1050861002000	VISOR NIVEL ACEITE	1
				10	ZT1251111013000	ESPARRAGO M6X25.5	3
				11	ZT1051354013000	SEGUER 24X1	1
				12	ZT1250601077000	RODAMIENTO 6201-C	1
				13	ZT1251512045000	ARANDELA 12.8X23X1	1
				14	ZT1051958002000	EJE BOMBA DE AGUA	1
				15	ZT1051958001000	BOMBA DE AGUA	1
				16	ZT1251512007000	ARANDELA 12.2X20X1	1
				17	ZT1250404006000	PERNO 9.2X5X18	1
				18	ZT1051954006000	RETEN DE AGUA	1
				19	ZT1051454008000	O-RING 19X1.5	1
				20	ZT1050358006000	ENGRANAJE BOMBA DE AGUA	1
				21	ZT1051954017000	TUBO ENTRADA Y SALIDA AGUA	1

FIG.	NOMBRE	IMAGEN CONJUNTO	IMAGEN DE PARTES	Nº	CÓDIGO	DESCRIPCIÓN	CANT.
29	SISTEMA DE ARRANQUE			1	ZT1051058004000	MOTOR DE ARRANQUE V2	1
				2	ZT4051658015000	ENGRANAJE DOBLE ARRANQUE 350	1
				3	ZT1251512007000	ARANDELA 12.2X20X1	2
				4	ZT1050358001000	ENGRANAJE INTERMEDIO DOBLE ARRANQUE V2	1
				5	ZT1251512004000	ARANDELA 10.2X21X1	2
				6	ZT1051058002000	VOLANTE MAGNETICO 350 (sin Blendix)	1
				7	ZT1051058008000	CORONA ARRANQUE 350	1
				8	ZT1051358005000	ARANDELA 28.2X40X1	2
				9	ZT1051058009000	RODAMIENTO AGUJAS 28X34X22	1
				10	ZT1051354006000	ARANDELA EMPUJE	1
				11	ZT1251500034000	RETEN 12.3X26X3	1
				12	ZT1251100065094	BULON M12X1.25X50	1
				13	ZT1251112002093	BULON M6X30	2
				14	ZT1051054021999	BLENDIX COMPLETO	1
				15			
				16			
				17			
				18			

FIG.	NOMBRE	IMAGEN CONJUNTO	IMAGEN DE PARTES	Nº	CÓDIGO	DESCRIPCIÓN	CANT.
30	DISTRIBUCIÓN			1	ZT1051261001000	CADENA DISTRIBUCIÓN 6.35X9X132	1
				2	ZT1050158004000	PATIN TENSOR CADENA DISTRIBUCIÓN	1
				3	ZT1050158005000	PATIN GUIA CADENA DISTRIBUCIÓN	1
				4	ZT1251100168093	BULON M6X15	1
				5	ZT1251512001000	ARANDELA 6.2X15X1	1
				6	ZT1050154034000	PLACA CADENA DISTRIBUCIÓN (9 MM)	1
				7	ZT1051253003000	TENSOR CADENA DISTRIBUCIÓN	1
				8	ZT1051253004000	JUNTA TENSOR CADENA DISTRIBUCIÓN	1
				9	ZT1251100067093	BULON M6X10	1
				10	ZT1251513001019	ARANDELA 6.3X12X1.6 COBRE	1
				11	ZT1251112002093	BULON M6X30	2
				12			
				13			
				14			
				15			
				16			
				17			
				18			



Jorge Peralta Martínez 2330, Los Troncos del Talar - CP. 1618 (B1608FEH) - Tigre, Buenos Aires, Argentina