



CATÁLOGO DE PIEZAS DE REPUESTO  
**ZONTES | G1 - 155**











**155 G1**





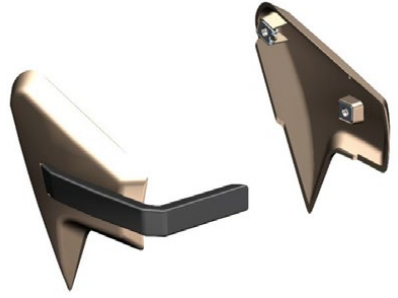





| FIG. | NOMBRE                 | IMAGEN CONJUNTO  | IMAGEN DE PARTES  | Nº | CÓDIGO          | DESCRIPCIÓN                     | CANT. |
|------|------------------------|--|---|----|-----------------|---------------------------------|-------|
| 1    |                        |   |   | 1  | ZT1161200041000 | Instrumental (Electrospray A)   |       |
|      |                        |  |   | 2  | ZT1020212099000 | Soporte Instrumental            | 1     |
|      |                        |  |   | 3  | ZT1250205040095 | Bulon M8X16                     | 2     |
|      |                        |  |   | 4  | ZT1251100102000 | Bulon M6X16 (No Std)            | 2     |
|      |                        |  |   | 5  | ZT1221200079000 | Cubre Instrumental              | 1     |
|      |                        |  |   | 6  | ZT1251300063093 | Grampa M6X11X15                 | 2     |
|      |                        |  |   | 7  | ZT1251200033093 | Parker Allen St4.2X12           | 1     |
|      |                        |  |   | 8  |                 |                                 |       |
|      |                        |  |   | 9  |                 |                                 |       |
| 2    | SOPORTE FARO DELANTERO |  |  | 1  | ZT1020212100000 | Soporte Superior Faro Delantero | 1     |
|      |                        |  |   | 2  | ZT1240400007000 | Silent-Block Bateria            | 2     |
|      |                        |  |   | 3  | ZT1224200008000 | Grapas Plastico De Cable        | 2     |
|      |                        |  |   | 4  | ZT1251100101000 | Bulon M6X12 (No Std)            | 2     |
|      |                        |  |   | 5  | ZT1250105138093 | Bulon M6x20                     | 2     |
|      |                        |  |   | 6  | ZT1251700059093 | Buje 6.4X9X8 + 18X2             | 2     |
|      |                        |  |   | 7  |                 |                                 |       |
|      |                        |  |   | 8  |                 |                                 |       |
|      |                        |  |   | 9  |                 |                                 |       |

| FIG. | NOMBRE               | IMAGEN CONJUNTO | IMAGEN DE PARTES | Nº | CÓDIGO          | DESCRIPCIÓN                     | CANT. |
|------|----------------------|-----------------|------------------|----|-----------------|---------------------------------|-------|
| 3    | FARO DELANTERO GRIS  |                 |                  | 1  | ZT1171200059000 | Faro Delantero                  | 1     |
|      |                      |                 |                  | 2  | ZT4041201094051 | Carcaza Faro Delantero Gris     | 1     |
|      |                      |                 |                  | 3  | ZT1251300063093 | Grampa M6X11X15                 | 3     |
|      |                      |                 |                  | 4  | ZT1251100101000 | Bulon M6X12 (No Std)            | 4     |
|      |                      |                 |                  | 5  | ZT1251100102000 | Bulon M6X16 (No Std)            | 4     |
|      |                      |                 |                  | 6  | ZT1244100052000 | Arandela Goma 8.5X14X1          | 4     |
|      |                      |                 |                  | 7  | ZT1274100057095 | Buje 6.2X8.5X3.5 + 14X1.5       | 4     |
|      |                      |                 |                  | 8  | ZT4021200034021 | Soporte Inferior Faro Delantero | 1     |
|      |                      |                 |                  | 9  |                 |                                 |       |
| 4    | FARO DELANTERO NEGRO |                 |                  | 1  | ZT1171200059000 | Faro Delantero                  | 1     |
|      |                      |                 |                  | 2  | ZT4041201095021 | Carcaza Faro Delantero Negro    | 1     |
|      |                      |                 |                  | 3  | ZT1251300063093 | Grampa M6X11X15                 | 3     |
|      |                      |                 |                  | 4  | ZT1251100101000 | Bulon M6X12 (No Std)            | 4     |
|      |                      |                 |                  | 5  | ZT1251100102000 | Bulon M6X16 (No Std)            | 4     |
|      |                      |                 |                  | 6  | ZT1244100052000 | Arandela Goma 8.5X14X1          | 4     |
|      |                      |                 |                  | 7  | ZT1274100057095 | Buje 6.2X8.5X3.5 + 14X1.5       | 4     |
|      |                      |                 |                  | 8  | ZT4021200034021 | Soporte Inferior Faro Delantero | 1     |
|      |                      |                 |                  | 9  |                 |                                 |       |





| FIG. | NOMBRE                       | IMAGEN CONJUNTO | IMAGEN DE PARTES | Nº | CÓDIGO          | DESCRIPCIÓN                           | CANT. |
|------|------------------------------|-----------------|------------------|----|-----------------|---------------------------------------|-------|
| 5    | SOPORTE FARO GIROS DELANTERO |                 |                  | 1  | ZT1221200084000 | Soporte Faro Giro Delantero Izquierdo | 1     |
|      |                              |                 |                  | 2  | ZT1221200085000 | Soporte Faro Giro Delantero Derecho   | 1     |
|      |                              |                 |                  | 3  | ZT1251100101000 | Bulon M6X12 (No Std)                  | 2     |
|      |                              |                 |                  | 4  | ZT1244100052000 | Arandela Goma 8.5X14X1                | 2     |
|      |                              |                 |                  | 5  | ZT1274100057095 | Buje 6.2X8.5X3.5 + 14X1.5             | 1     |
|      |                              |                 |                  | 6  | ZT1224100010000 | Remache Plastico Expansión            | 4     |
|      |                              |                 |                  | 7  | ZT1274100018000 | Buje Separador Silenciador            | 1     |
|      |                              |                 |                  | 8  |                 |                                       |       |
|      |                              |                 |                  | 9  |                 |                                       |       |
| 6    | FARO GIROS DELANTERO         |                 |                  | 1  | ZT1170300063000 | Faro Giro Del. Izquierdo              | 1     |
|      |                              |                 |                  | 2  | ZT1170300064000 | Faro Giro Del. Derecho                | 1     |
|      |                              |                 |                  | 3  | ZT1221200115000 | Protector Faro Giro (juego)           | 2     |
|      |                              |                 |                  | 4  |                 |                                       |       |
|      |                              |                 |                  | 5  |                 |                                       |       |
|      |                              |                 |                  | 6  |                 |                                       |       |
|      |                              |                 |                  | 7  |                 |                                       |       |
|      |                              |                 |                  | 8  |                 |                                       |       |
|      |                              |                 |                  | 9  |                 |                                       |       |



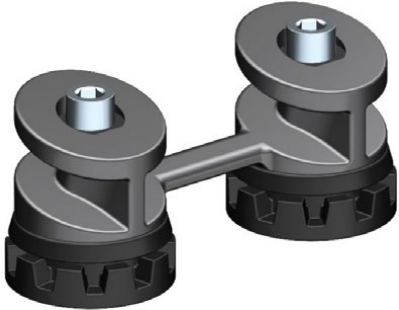

| FIG. | NOMBRE                        | IMAGEN CONJUNTO  | IMAGEN DE PARTES   |   |   | Nº | CÓDIGO          | DESCRIPCIÓN                       | CANT. |
|------|-------------------------------|--|--|---|---|----|-----------------|-----------------------------------|-------|
| 7    | CACHAS FARO DELANTERO NEGRO   |   |  |  |  | 1  | ZT4041201096051 | Cacha Faro Delantero Izq. Negro   | 1     |
|      |                               |  |  |   |   | 2  | ZT4041201098051 | Cacha Faro Delantero Der. Negro   | 1     |
|      |                               |  |  |   |   | 3  | ZT1210412025000 | Insignia ZONTES Faro Delantero    | 1     |
|      |                               |  |  |   |   | 4  | ZT1251300063093 | Grampa M6X11X15                   | 3     |
|      |                               |  |  |   |   | 5  |                 |                                   |       |
|      |                               |  |  |   |   | 6  |                 |                                   |       |
|      |                               |  |  |   |   | 7  |                 |                                   |       |
|      |                               |  |  |   |   | 8  |                 |                                   |       |
|      |                               |  |  |   |   | 9  |                 |                                   |       |
| 8    | CACHAS FARO DELANTERO TITANIO |  |  |  |  | 1  | ZT4041201097035 | Cacha Faro Delantero Izq. Titanio | 1     |
|      |                               |  |  |   |   | 2  | ZT4041201099035 | Cacha Faro Delantero Der. Titanio | 1     |
|      |                               |  |  |   |   | 3  | ZT1210412025000 | Insignia ZONTES Faro Delantero    | 1     |
|      |                               |  |  |   |   | 4  | ZT1251300063093 | Grampa M6X11X15                   | 3     |
|      |                               |  |  |   |   | 5  |                 |                                   |       |
|      |                               |  |  |   |   | 6  |                 |                                   |       |
|      |                               |  |  |   |   | 7  |                 |                                   |       |
|      |                               |  |  |   |   | 8  |                 |                                   |       |
|      |                               |  |  |   |   | 9  |                 |                                   |       |



| FIG. | NOMBRE                      | IMAGEN CONJUNTO | IMAGEN DE PARTES | Nº | CÓDIGO          | DESCRIPCIÓN  | CANT. |
|------|-----------------------------|-----------------|------------------|----|-----------------|--|-------|
| 9    | GUARDABARRO DELANTERO GRIS  |                 |                  | 1  | ZT4041201284021 | Guardabarro Delantero Anterior Negro               | 1     |
|      |                             |                 |                  | 2  | ZT4041201086051 | Guardabarro Delantero Frontal Gris                 | 1     |
|      |                             |                 |                  | 3  | ZT1251300063093 | Grampa M6X11X15                                    | 4     |
|      |                             |                 |                  | 4  | ZT1251100102000 | Bulon M6X16 (No Std)                               | 6     |
|      |                             |                 |                  | 5  | ZT1244100052000 | Arandela Goma 8.5X14X1                             | 10    |
|      |                             |                 |                  | 6  | ZT1274100057095 | Buje 6.2X8.5X3.5 + 14X1.5                          | 10    |
|      |                             |                 |                  | 7  | ZT1274200038000 | Soporte Fijación Flexible Freno Del En Guardabarro | 1     |
|      |                             |                 |                  | 8  | ZT1250402001091 | Remache 3X10                                       | 1     |
|      |                             |                 |                  | 9  | ZT1251100101000 | Bulon M6X12 (No Std)                               | 4     |
| 10   | GUARDABARRO DELANTERO NEGRO |                 |                  | 1  | ZT4041201283021 | Guardabarro Delantero Anterior Titanio             | 1     |
|      |                             |                 |                  | 2  | ZT4041201087021 | Guardabarro Delantero Frontal Negro                | 1     |
|      |                             |                 |                  | 3  | ZT1251300063093 | Grampa M6X11X15                                    | 4     |
|      |                             |                 |                  | 4  | ZT1251100102000 | Bulon M6X16 (No Std)                               | 6     |
|      |                             |                 |                  | 5  | ZT1244100052000 | Arandela Goma 8.5X14X1                             | 10    |
|      |                             |                 |                  | 6  | ZT1274100057095 | Buje 6.2X8.5X3.5 + 14X1.5                          | 10    |
|      |                             |                 |                  | 7  | ZT1274200038000 | Soporte Fijación Flexible Freno Del En Guardabarro | 1     |
|      |                             |                 |                  | 8  | ZT1250402001091 | Remache 3X10                                       | 1     |
|      |                             |                 |                  | 9  | ZT1251100101000 | Bulon M6X12 (No Std)                               | 4     |

| FIG. | NOMBRE                           | IMAGEN CONJUNTO  | IMAGEN DE PARTES   | Nº | CÓDIGO          | DESCRIPCIÓN  | CANT. |
|------|----------------------------------|--|--|----|-----------------|--|-------|
| 11   | GUARDABARRO DELANTERO AMARILLO   |   |        | 1  | ZT4041201284021 | Guardabarro Delantero Anterior Negro               | 1     |
|      |                                  |  |  | 2  | ZT4041201124031 | Guardabarro Delantero Frontal Amarillo             | 1     |
|      |                                  |  |  | 3  | ZT1251300063093 | Grampa M6X11X15                                    | 4     |
|      |                                  |  |  | 4  | ZT1251100102000 | Bulon M6X16 (No Std)                               | 6     |
|      |                                  |  |  | 5  | ZT1244100052000 | Arandela Goma 8.5X14X1                             | 10    |
|      |                                  |  |  | 6  | ZT1274100057095 | Buje 6.2X8.5X3.5 + 14X1.5                          | 10    |
|      |                                  |  |  | 7  | ZT1274200038000 | Soporte Fijación Flexible Freno Del En Guardabarro | 1     |
|      |                                  |  |  | 8  | ZT1250402001091 | Remache 3X10                                       | 1     |
|      |                                  |  |  | 9  | ZT1251100101000 | Bulon M6X12 (No Std)                               | 4     |
| 12   | TANQUE COMBUSTIBLE NEGRO/TITANIO |  |    | 1  | ZT4031200115021 | Tanque Combustible Negro/Titanio                   | 1     |
|      |                                  |  |  | 2  | ZT1210201485000 | Calco Tanque Combustible Izq.                      | 1     |
|      |                                  |  |  | 3  | ZT1210201486000 | Calco Tanque Combustible Der.                      | 1     |
|      |                                  |  |  | 4  | ZT1210312022051 | Calco Tanque Combustible Frontal Titanio           | 1     |
|      |                                  |  |  | 5  | ZT1210312023051 | Calco Tanque Combustible Trasero Titanio           | 1     |
|      |                                  |  |  | 6  | ZT1181200101000 | Llave Contacto Completa                            | 1     |
|      |                                  |  |  | 7  | ZT1050956011000 | Bomba Combustible con Flotante                     | 1     |
|      |                                  |  |  | 8  | ZT1250105137093 | Bulon M6X16  | 8     |
|      |                                  |  |  | 9  | ZT1240300021000 | Barra Goma Del Deflector Viento                    | 1     |





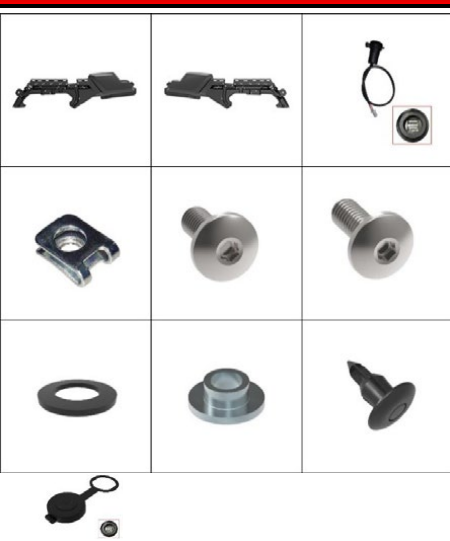



| FIG. | NOMBRE                        | IMAGEN CONJUNTO | IMAGEN DE PARTES | Nº | CÓDIGO          | DESCRIPCIÓN                           | CANT. |
|------|-------------------------------|-----------------|------------------|----|-----------------|---------------------------------------|-------|
| 13   | TANQUE COMBUSTIBLE NEGRO/GRIS |                 |                  | 1  | ZT4031200116021 | Tanque Combustible Gris               | 1     |
|      |                               |                 |                  | 2  | ZT1210201485000 | Calco Tanque Combustible Izq.         | 1     |
|      |                               |                 |                  | 3  | ZT1210201486000 | Calco Tanque Combustible Der.         | 1     |
|      |                               |                 |                  | 4  | ZT1210312093052 | Calco Tanque Combustible Frontal Gris | 1     |
|      |                               |                 |                  | 5  | ZT1210312094052 | Calco Tanque Combustible Trasero Gris | 1     |
|      |                               |                 |                  | 6  | ZT1181200101000 | Llave Contacto Completa               | 1     |
|      |                               |                 |                  | 7  | ZT1050956011000 | Bomba Combustible con Flotante        | 1     |
|      |                               |                 |                  | 8  | ZT1250105137093 | Bulon M6X16                           | 8     |
|      |                               |                 |                  | 9  | ZT1240300021000 | Barra Goma Del Deflector Viento       | 1     |
| 14   | TANQUE COMBUSTIBLE AMARILLO   |                 |                  | 1  | ZT4031200117031 | Tanque Combustible Amarillo           | 1     |
|      |                               |                 |                  | 2  | ZT1210201485000 | Calco Tanque Combustible Izq.         | 1     |
|      |                               |                 |                  | 3  | ZT1210201486000 | Calco Tanque Combustible Der.         | 1     |
|      |                               |                 |                  | 4  | ZT1210312093052 | Calco Tanque Combustible Frontal Gris | 1     |
|      |                               |                 |                  | 5  | ZT1210312094052 | Calco Tanque Combustible Trasero Gris | 1     |
|      |                               |                 |                  | 6  | ZT1181200101000 | Llave Contacto Completa               | 1     |
|      |                               |                 |                  | 7  | ZT1050956011000 | Bomba Combustible con Flotante        | 1     |
|      |                               |                 |                  | 8  | ZT1250105137093 | Bulon M6X16                           | 8     |
|      |                               |                 |                  | 9  | ZT1240300021000 | Barra Goma Del Deflector Viento       | 1     |





| FIG. | NOMBRE                 | IMAGEN CONJUNTO   | IMAGEN DE PARTES   |    |                             | Nº   | CÓDIGO  | DESCRIPCIÓN | CANT.           |
|------|------------------------|---|--|----|-----------------------------|--|---|-------------|-----------------|
| 15   | SOPORTE TRASERO TANQUE |  |  | 1  | ZT1250205023000             | Bulon M8X35 Allen  | 2   |             |                 |
|      |                        |   |  | 2  | ZT1244100023000             | Soporte Trasero Tanque Combustible   | 1   |             |                 |
|      |                        |   |  | 3  | ZT1244100020000             | Goma Presión De Tanque Combustible   | 2   |             |                 |
|      |                        |   |  | 4  | ZT1244100053000             | Buje Goma De Tanque Combustible Segundo  | 2   |             |                 |
|      |                        |   |  | 6  |                             |  |   |             |                 |
|      |                        |   |  | 7  |                             |  |   |             |                 |
|      |                        |   |  | 8  |                             |  |   |             |                 |
|      |                        |   |  | 9  |                             |  |   |             |                 |
|      |                        |   |  | 16 | CACHA SUPERIOR FRONTAL GRIS |  |  | 1           | ZT4041201106051 |
| 2    | ZT4041201108051        | Cacha Sup. Der. Frontal Gris  | 1  |    |                             |  |   |             |                 |
| 3    | ZT1251300063093        | Grampa M6X11X15   | 8  |    |                             |  |   |             |                 |
| 4    | ZT1224100010000        | Remache Plastico Expansión  | 4  |    |                             |  |   |             |                 |
| 5    | ZT1221200077000        | Cacha Sup. Int. Izquierda   | 1  |    |                             |  |   |             |                 |
| 6    | ZT1221200078000        | Cacha Sup. Int. Derecha   | 1  |    |                             |  |   |             |                 |
| 7    | ZT1251100102000        | Bulon M6X16 (No Std)  | 4  |    |                             |  |   |             |                 |
| 8    | ZT1244100052000        | Arandela Goma 8.5X14X1  | 4  |    |                             |  |   |             |                 |
| 9    | ZT1274100057095        | Buje 6.2X8.5X3.5 + 14X1.5   | 4  |    |                             |  |   |             |                 |





| FIG. | NOMBRE                          | IMAGEN CONJUNTO  | IMAGEN DE PARTES  | Nº | CÓDIGO          | DESCRIPCIÓN                   | CANT. |
|------|---------------------------------|--|---|----|-----------------|-------------------------------|-------|
| 17   | CACHA SUPERIOR<br>FRONTAL NEGRO |   |   | 1  | ZT4041201110021 | Cacha Sup. Izq. Frontal Negro | 1     |
|      |                                 |  |   | 2  | ZT4041201112021 | Cacha Sup. Der. Frontal Negro | 1     |
|      |                                 |  |   | 3  | ZT1251300063093 | Grampa M6X11X15               | 8     |
|      |                                 |  |   | 4  | ZT1224100010000 | Remache Plastico Expansión    | 4     |
|      |                                 |  |   | 5  | ZT1221200077000 | Cacha Sup. Int. Izq.          | 1     |
|      |                                 |  |   | 6  | ZT1221200078000 | Cacha Sup. Int. Der.          | 1     |
|      |                                 |  |   | 7  | ZT1251100102000 | Bulon M6X16 (No Std)          | 4     |
|      |                                 |  |   | 8  | ZT1244100052000 | Arandela Goma 8.5X14X1        | 4     |
|      |                                 |  |   | 9  | ZT1274100057095 | Buje 6.2X8.5X3.5 + 14X1.5     | 4     |
| 18   | REJILLA FRONTAL                 |  |  | 1  | ZT1221200081000 | Rejilla Frontal Izq.          | 1     |
|      |                                 |  |   | 2  | ZT1221200082000 | Rejilla Frontal Der.          | 1     |
|      |                                 |  |   | 3  | ZT1251100101000 | Bulon M6X12 (No Std)          | 2     |
|      |                                 |  |   | 4  | ZT1251100102000 | Bulon M6X16 (No Std)          | 2     |
|      |                                 |  |   | 5  | ZT1224100010000 | Remache Plastico Expansión    | 2     |
|      |                                 |  |   | 6  |                 |                               |       |
|      |                                 |  |   | 7  |                 |                               |       |
|      |                                 |  |   | 8  |                 |                               |       |
|      |                                 |  |   | 9  |                 |                               |       |

| FIG. | NOMBRE             | IMAGEN CONJUNTO  | IMAGEN DE PARTES  | Nº | CÓDIGO          | DESCRIPCIÓN                | CANT. |
|------|--------------------|--|---|----|-----------------|----------------------------|-------|
| 19   | CACHA TANQUE GRIS  |   |   | 1  | ZT4041201102051 | Cacha Tanque Izq. Gris     | 1     |
|      |                    |  |   | 2  | ZT4041201104051 | Cacha Tanque Der. Gris     | 1     |
|      |                    |  |   | 3  | ZT1184200100000 | Usb General Doble Puerto   | 1     |
|      |                    |  |   | 4  | ZT1251300063093 | Grampa M6X11X15            | 4     |
|      |                    |  |   | 5  | ZT1251100101000 | Bulon M6X12 (No Std)       | 4     |
|      |                    |  |   | 6  | ZT1251100102000 | Bulon M6X16 (No Std)       | 2     |
|      |                    |  |   | 7  | ZT1244100052000 | Arandela Goma 8.5X14X1     | 2     |
|      |                    |  |   | 8  | ZT1274100057095 | Buje 6.2X8.5X3.5 + 14X1.5  | 2     |
|      |                    |  |   | 9  | ZT1224100010000 | Remache Plastico Expansión | 2     |
|      |                    |  |   | 10 | ZT1244200109000 | Tapa Usb                   | 1     |
| 20   | CACHA TANQUE NEGRO |  |  | 1  | ZT4041201103021 | Cacha Tanque Izq. Negro    | 1     |
|      |                    |  |   | 2  | ZT4041201105021 | Cacha Tanque Der. Negro    | 1     |
|      |                    |  |   | 3  | ZT1184200100000 | Usb General Doble Puerto   | 1     |
|      |                    |  |   | 4  | ZT1251300063093 | Grampa M6X11X15            | 4     |
|      |                    |  |   | 5  | ZT1251100101000 | Bulon M6X12 (No Std)       | 4     |
|      |                    |  |   | 6  | ZT1251100102000 | Bulon M6X16 (No Std)       | 2     |
|      |                    |  |   | 7  | ZT1244100052000 | Arandela Goma 8.5X14X1     | 2     |
|      |                    |  |   | 8  | ZT1224100010000 | Remache Plastico Expansión | 2     |
|      |                    |  |   | 9  | ZT1224100010000 | Remache Plastico Expansión | 2     |
|      |                    |  |   | 10 | ZT1244200109000 | Tapa Usb                   | 1     |





| FIG. | NOMBRE                                 | IMAGEN CONJUNTO | IMAGEN DE PARTES | Nº | CÓDIGO          | DESCRIPCIÓN                       | CANT. |
|------|--|-----------------|------------------|----|-----------------|-----------------------------------|-------|
| 21   | CACHA INFERIOR IZQUIERDO FRONTAL GRIS  |                 |                  | 1  | ZT4041201107051 | Cacha Inferior Izq. Frontal Gris  | 1     |
|      |  |                 |                  | 2  | ZT1271200073000 | Soporte Cacha Inf. Izq. Frontal   | 1     |
|      |  |                 |                  | 3  | ZT1244100002000 | Silent-Block Cachas Tanque        | 2     |
|      |  |                 |                  | 4  | ZT1251300063093 | Grampa M6X11X15                   | 2     |
|      |  |                 |                  | 5  | ZT1251100102000 | Bulon M6X16 (No Std)              | 2     |
|      |  |                 |                  | 6  | ZT1244100052000 | Arandela Goma 8.5X14X1            | 2     |
|      |  |                 |                  | 7  | ZT1274100057095 | Buje 6.2X8.5X3.5 + 14X1.5         | 2     |
|      |  |                 |                  | 8  | ZT1224100010000 | Remache Plastico Expansión        | 1     |
|      |  |                 |                  | 9  |                 |                                   |       |
| 22   | CACHA INFERIOR IZQUIERDO FRONTAL NEGRO |                 |                  | 1  | ZT4041201111021 | Cacha Inferior Izq. Frontal Negro | 1     |
|      |  |                 |                  | 2  | ZT1271200073000 | Soporte Inf. Izq. Frontal         | 1     |
|      |  |                 |                  | 3  | ZT1244100002000 | Silent-Block Cachas Tanque        | 2     |
|      |  |                 |                  | 4  | ZT1251300063093 | Grampa M6X11X15                   | 2     |
|      |  |                 |                  | 5  | ZT1251100102000 | Bulon M6X16 (No Std)              | 2     |
|      |  |                 |                  | 6  | ZT1244100052000 | Arandela Goma 8.5X14X1            | 2     |
|      |  |                 |                  | 7  | ZT1274100057095 | Buje 6.2X8.5X3.5 + 14X1.5         | 2     |
|      |  |                 |                  | 8  | ZT1224100010000 | Remache Plastico Expansión        | 1     |
|      |  |                 |                  | 9  |                 |                                   |       |

| FIG. | NOMBRE                               | IMAGEN CONJUNTO  | IMAGEN DE PARTES   |   |   | Nº | CÓDIGO          | DESCRIPCIÓN                       | CANT. |
|------|--------------------------------------|--|--|---|---|----|-----------------|-----------------------------------|-------|
| 23   | CACHA INFERIOR DERECHO FRONTAL GRIS  |   |  |  |  | 1  | ZT4041201109051 | Cacha Inferior Der. Frontal Gris  | 1     |
|      |                                      |  |  |   |   | 2  | ZT1271200071000 | Soporte Inf. Der. Frontal         | 1     |
|      |                                      |  |  |   |   | 3  | ZT1244100002000 | Silent-Block Cachas Tanque        | 2     |
|      |                                      |  |  |   |   | 4  | ZT1251300063093 | Grampa M6X11X15                   | 2     |
|      |                                      |  |  |   |   | 5  | ZT1251100102000 | Bulon M6X16 (No Std)              | 2     |
|      |                                      |  |  |   |   | 6  | ZT1244100052000 | Arandela Goma 8.5X14X1            | 2     |
|      |                                      |  |  |   |   | 7  | ZT1274100057095 | Buje 6.2X8.5X3.5 + 14X1.5         | 2     |
|      |                                      |  |  |   |   | 8  | ZT1224100010000 | Remache Plastico Expansión        | 1     |
|      |                                      |  |  |   |   | 9  |                 |                                   |       |
| 24   | CACHA INFERIOR DERECHO FRONTAL NEGRO |  |  |  |  | 1  | ZT4041201113021 | Cacha Inferior Der. Frontal Negro | 1     |
|      |                                      |  |  |   |   | 2  | ZT1271200071000 | Soporte Inf. Der. Frontal         | 1     |
|      |                                      |  |  |   |   | 3  | ZT1244100002000 | Silent-Block Cachas Tanque        | 2     |
|      |                                      |  |  |   |   | 4  | ZT1251300063093 | Grampa M6X11X15                   | 2     |
|      |                                      |  |  |   |   | 5  | ZT1251100102000 | Bulon M6X16 (No Std)              | 2     |
|      |                                      |  |  |   |   | 6  | ZT1244100052000 | Arandela Goma 8.5X14X1            | 2     |
|      |                                      |  |  |   |   | 7  | ZT1274100057095 | Buje 6.2X8.5X3.5 + 14X1.5         | 2     |
|      |                                      |  |  |   |   | 8  | ZT1224100010000 | Remache Plastico Expansión        | 1     |
|      |                                      |  |  |   |   | 9  |                 |                                   |       |





| FIG. | NOMBRE                | IMAGEN CONJUNTO  | IMAGEN DE PARTES  | Nº | CÓDIGO          | DESCRIPCIÓN                | CANT. |
|------|-----------------------|--|---|----|-----------------|----------------------------|-------|
| 25   | REJILLA FRONTAL MOTOR |   |   | 1  | ZT1221200076000 | Rejilla Frontal Motor      | 1     |
|      |                       |  |   | 2  | ZT1251100101000 | Bulon M6X12 (No Std)       | 2     |
|      |                       |  |   | 3  | ZT1251100102000 | Bulon M6X16 (No Std)       | 2     |
|      |                       |  |   | 4  | ZT1244100052000 | Arandela Goma 8.5X14X1     | 2     |
|      |                       |  |   | 5  | ZT1274100057095 | Buje 6.2X8.5X3.5 + 14X1.5  | 2     |
|      |                       |  |   | 6  | ZT1224100010000 | Remache Plastico Expansión | 2     |
|      |                       |  |   | 7  |                 |                            |       |
|      |                       |  |   | 8  |                 |                            |       |
|      |                       |  |   | 9  |                 |                            |       |
| 26   | ASIENTO               |  |  | 1  | ZT1200100434000 | Asiento                    | 1     |
|      |                       |  |   | 2  | ZT1244100024000 | Goma Frontal Asiento       | 2     |
|      |                       |  |   | 3  | ZT1244300033000 | Goma Asiento               | 2     |
|      |                       |  |   | 4  | ZT1244100025000 | Tope Silent-Block Asiento  | 6     |
|      |                       |  |   | 5  |                 |                            |       |
|      |                       |  |   | 6  |                 |                            |       |
|      |                       |  |   | 7  |                 |                            |       |
|      |                       |  |   | 8  |                 |                            |       |
|      |                       |  |   | 9  |                 |                            |       |





| FIG. | NOMBRE                 | IMAGEN CONJUNTO  | IMAGEN DE PARTES   | Nº | CÓDIGO          | DESCRIPCIÓN                    | CANT. |
|------|------------------------|--|--|----|-----------------|--------------------------------|-------|
| 27   | CACHAS LATERAL GRIS    |   |  | 1  | ZT4041201161021 | Cacha Lateral Derecha Gris     | 1     |
|      |                        |  |  | 2  | ZT4041201160021 | Cacha Lateral Izquierda Gris   | 1     |
|      |                        |  |  | 3  |                 |                                |       |
|      |                        |  |  | 4  |                 |                                |       |
|      |                        |  |  | 5  |                 |                                |       |
|      |                        |  |  | 6  |                 |                                |       |
|      |                        |  |  | 7  |                 |                                |       |
|      |                        |  |  | 8  |                 |                                |       |
|      |                        |  |  | 9  |                 |                                |       |
| 28   | CACHAS LATERAL TITANIO |  |  | 1  | ZT4041201159021 | Cacha Lateral Derecha Titanio  | 1     |
|      |                        |  |  | 2  | ZT4041201158021 | Cacha Lateral IzquierdaTitanio | 1     |
|      |                        |  |  | 3  |                 |                                |       |
|      |                        |  |  | 4  |                 |                                |       |
|      |                        |  |  | 5  |                 |                                |       |
|      |                        |  |  | 6  |                 |                                |       |
|      |                        |  |  | 7  |                 |                                |       |
|      |                        |  |  | 8  |                 |                                |       |
|      |                        |  |  | 9  |                 |                                |       |

| FIG. | NOMBRE                 | IMAGEN CONJUNTO | IMAGEN DE PARTES | Nº | CÓDIGO          | DESCRIPCIÓN                     | CANT. |
|------|------------------------|-----------------|------------------|----|-----------------|---------------------------------|-------|
| 29   | CACHAS TRASERA GRIS    |                 |                  | 1  | ZT4041201114051 | Cacha Trasera Izquierda Gris    | 1     |
|      |                        |                 |                  | 2  | ZT4041201115051 | Cacha Trasera Derecha Gris      | 1     |
|      |                        |                 |                  | 3  | ZT1244100002000 | Silent-Block Cachas Tanque      | 6     |
|      |                        |                 |                  | 4  | ZT1251300063093 | Grampa M6X11X15                 | 4     |
|      |                        |                 |                  | 5  | ZT1224100010000 | Remache Plastico Expansión      | 2     |
|      |                        |                 |                  | 6  | ZT1221200075000 | Tapa Rejilla Cacha Trasera      | 2     |
|      |                        |                 |                  | 7  | ZT1271200131000 | Rejilla Cacha Trasera           | 2     |
|      |                        |                 |                  | 8  | ZT1251200038093 | Parker St 3.9X12                | 6     |
|      |                        |                 |                  | 9  | ZT1240300021000 | Barra Goma Del Deflector Viento | 1     |
| 30   | CACHAS TRASERA TITANIO |                 |                  | 1  | ZT4041201116035 | Cacha Trasera Izquierda Titanio | 1     |
|      |                        |                 |                  | 2  | ZT4041201117035 | Cacha Trasera Derecha Titanio   | 1     |
|      |                        |                 |                  | 3  | ZT1244100002000 | Silent-Block Cachas Tanque      | 6     |
|      |                        |                 |                  | 4  | ZT1251300063093 | Grampa M6X11X15                 | 4     |
|      |                        |                 |                  | 5  | ZT1224100010000 | Remache Plastico Expansión      | 2     |
|      |                        |                 |                  | 6  | ZT1221200075000 | Tapa Rejilla Cacha Trasera      | 2     |
|      |                        |                 |                  | 7  | ZT1271200131000 | Rejilla Cacha Trasera           | 2     |
|      |                        |                 |                  | 8  | ZT1251200038093 | Parker St 3.9X12                | 6     |
|      |                        |                 |                  | 9  | ZT1240300021000 | Barra Goma Del Deflector Viento | 1     |





| FIG. | NOMBRE                 | IMAGEN CONJUNTO  | IMAGEN DE PARTES  | Nº | CÓDIGO          | DESCRIPCIÓN                  | CANT. |
|------|------------------------|--|---|----|-----------------|------------------------------|-------|
| 31   | MANIJAS DE ACOMPAÑANTE |   |   | 1  | ZT4021200035021 | Manija Acompañante Izquierdo | 1     |
|      |                        |  |   | 2  | ZT4021200036021 | Manija Acompañante Derecho   | 1     |
|      |                        |  |   | 3  | ZT1251100123093 | Bulon M8X25                  | 4     |
|      |                        |  |   | 4  | ZT1251100102000 | Bulon M6X16 (No Std)         | 4     |
|      |                        |  |   | 5  |                 |                              |       |
|      |                        |  |   | 6  |                 |                              |       |
|      |                        |  |   | 7  |                 |                              |       |
|      |                        |  |   | 8  |                 |                              |       |
|      |                        |  |   | 9  |                 |                              |       |
| 32   | FARO TRASERO           |  |  | 1  | ZT1171200060000 | Faro Trasero                 | 1     |
|      |                        |  |   | 2  | ZT1251300063093 | Grampa M6X11X15              | 3     |
|      |                        |  |   | 3  | ZT1251100102000 | Bulon M6X16 (No Std)         | 2     |
|      |                        |  |   | 4  | ZT1244100052000 | Arandela Goma 8.5X14X1       | 2     |
|      |                        |  |   | 5  | ZT1274100057095 | Buje 6.2X8.5X3.5 + 14X1.5    | 2     |
|      |                        |  |   | 6  |                 |                              |       |
|      |                        |  |   | 7  |                 |                              |       |
|      |                        |  |   | 8  |                 |                              |       |
|      |                        |  |   | 9  |                 |                              |       |



| FIG. | NOMBRE                      | IMAGEN CONJUNTO | IMAGEN DE PARTES | Nº | CÓDIGO          | DESCRIPCIÓN                    | CANT. |
|------|-----------------------------|-----------------|------------------|----|-----------------|--------------------------------|-------|
| 33   | CAJA COMPONENTES ELECTRICOS |                 |                  | 1  | ZT1221200070000 | Caja de Componentes Electricos | 1     |
|      |                             |                 |                  | 2  | ZT1251300063093 | Grampa M6X11X15                | 2     |
|      |                             |                 |                  | 3  | ZT1251100102000 | Bulon M6X16 (No Std)           | 2     |
|      |                             |                 |                  | 4  | ZT1244100052000 | Arandela Goma 8.5X14X1         | 2     |
|      |                             |                 |                  | 5  | ZT1274100057095 | Buje 6.2X8.5X3.5 + 14X1.5      | 2     |
|      |                             |                 |                  | 6  | ZT1224100010000 | Remache Plastico Expansión     | 6     |
|      |                             |                 |                  | 7  | ZT1240100023000 | Protector Borne De Batería     | 1     |
|      |                             |                 |                  | 8  | ZT1224200040000 | Tapa Pke                       | 1     |
|      |                             |                 |                  | 9  |                 |                                |       |
| 34   | BATERIA DE GEL              |                 |                  | 1  | ZT1271200144000 | Soporte Batería                | 1     |
|      |                             |                 |                  | 2  | ZT1240300007000 | Goma Silent-Block Batería      | 4     |
|      |                             |                 |                  | 3  | ZT1251100102000 | Bulon M6X16 (No Std)           | 4     |
|      |                             |                 |                  | 4  | ZT1184200099000 | Batería De Gel                 | 1     |
|      |                             |                 |                  | 5  | ZT1244200111000 | Cinto Fijacion De Batería      | 1     |
|      |                             |                 |                  | 6  | ZT1184200163000 | Cargador De Bateria Gel        | 1     |
|      |                             |                 |                  | 7  |                 |                                |       |
|      |                             |                 |                  | 8  |                 |                                |       |
|      |                             |                 |                  | 9  |                 |                                |       |



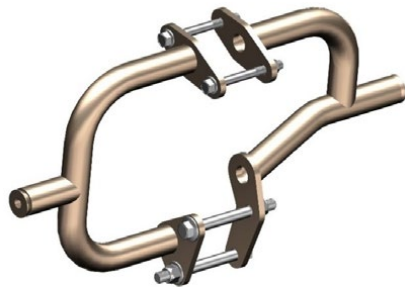



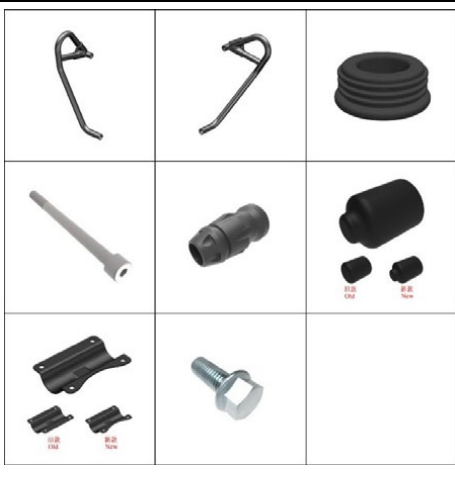

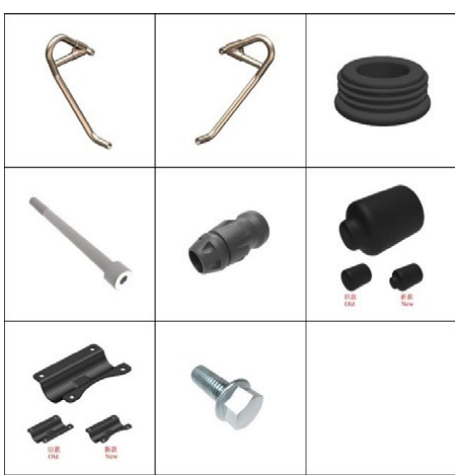
| FIG. | NOMBRE                           | IMAGEN CONJUNTO  | IMAGEN DE PARTES  | Nº | CÓDIGO          | DESCRIPCIÓN                      | CANT. |
|------|----------------------------------|--|---|----|-----------------|----------------------------------|-------|
| 35   | TAPA CAJA COMPONENTES ELECTRICOS |   |   | 1  | ZT1221200113000 | Tapa Caja Componentes Electricos | 1     |
|      |                                  |  |   | 2  | ZT1251100102000 | Bulon M6X16 (No Std)             | 2     |
|      |                                  |  |   | 3  | ZT1274100057095 | Buje 6.2X8.5X3.5 + 14X1.5        | 2     |
|      |                                  |  |   | 4  | ZT1244100052000 | Arandela Goma 8.5X14X1           | 2     |
|      |                                  |  |   | 5  | ZT1224100010000 | Remache Plastico Expansión       | 2     |
|      |                                  |  |   | 6  |                 |                                  |       |
|      |                                  |  |   | 7  |                 |                                  |       |
|      |                                  |  |   | 8  |                 |                                  |       |
|      |                                  |  |   | 9  |                 |                                  |       |
| 36   | TAPA INFERIOR DE COLIN           |  |  | 1  | ZT1221200072000 | Tapa Inferior de Colin           | 1     |
|      |                                  |  |   | 2  | ZT1251100122093 | Bulon M8X16                      | 4     |
|      |                                  |  |   | 3  | ZT1240300071000 | Arandela Goma 11X16X1            | 4     |
|      |                                  |  |   | 4  | ZT1251700058093 | Buje 8.2X11X4.5 + 16X1.5         | 4     |
|      |                                  |  |   | 5  | ZT1244200087000 | Goma Tapa Inferior De Colin X2   | 2     |
|      |                                  |  |   | 6  |                 |                                  |       |
|      |                                  |  |   | 7  |                 |                                  |       |
|      |                                  |  |   | 8  |                 |                                  |       |
|      |                                  |  |   | 9  |                 |                                  |       |

| FIG. | NOMBRE              | IMAGEN CONJUNTO  | IMAGEN DE PARTES  | Nº | CÓDIGO          | DESCRIPCIÓN                     | CANT. |
|------|---------------------|--|---|----|-----------------|---------------------------------|-------|
| 37   | FAROS GIRO TRASERO  |   |   | 1  | ZT1170300065000 | Faro Giro Izq. Trasero          | 1     |
|      |                     |  |   | 2  | ZT1170300066000 | Faro Giro Der. Trasero          | 1     |
|      |                     |  |   | 3  | ZT1221200115000 | Cubre Faro Giros                | 2     |
|      |                     |  |   | 4  |                 |                                 |       |
|      |                     |  |   | 5  |                 |                                 |       |
|      |                     |  |   | 6  |                 |                                 |       |
|      |                     |  |   | 7  |                 |                                 |       |
|      |                     |  |   | 8  |                 |                                 |       |
|      |                     |  |   | 9  |                 |                                 |       |
| 38   | GUARDABARRO TRASERO |  |  | 1  | ZT1221200073000 | Guardabarro Trasero             | 1     |
|      |                     |  |   | 2  | ZT1251100102000 | Bulon M6X16 (No Std)            | 3     |
|      |                     |  |   | 3  | ZT1244100052000 | Arandela Goma 8.5X14X1          | 3     |
|      |                     |  |   | 4  | ZT1274100057095 | Buje 6.2X8.5X3.5 + 14X1.5       | 3     |
|      |                     |  |   | 5  | ZT1224100010000 | Remache Plastico Expansión      | 1     |
|      |                     |  |   | 6  | ZT1221200074000 | Cobertor Inf. Guardabarro Tras. | 1     |
|      |                     |  |   | 7  | ZT1174100002000 | Ojo Gato Trasero                | 1     |
|      |                     |  |   | 8  | ZT1174200021000 | Faro Patente                    | 1     |
|      |                     |  |   | 9  |                 |                                 |       |

| FIG. | NOMBRE                            | IMAGEN CONJUNTO | IMAGEN DE PARTES | Nº | CÓDIGO          | DESCRIPCIÓN                       | CANT. |
|------|-----------------------------------|-----------------|------------------|----|-----------------|-----------------------------------|-------|
| 39   | SOPORTE<br>GUARDABARRO<br>TRASERO |                 |                  | 1  | ZT1271200177000 | Soporte Guardabarro Trasero       | 1     |
|      |                                   |                 |                  | 2  | ZT1251100102000 | Bulon M6X16 (No Std)              | 4     |
|      |                                   |                 |                  | 3  | ZT1221200068000 | Soporte de Patente                | 1     |
|      |                                   |                 |                  | 4  | ZT1244100052000 | Arandela Goma 8.5X14X1            | 3     |
|      |                                   |                 |                  | 5  | ZT1274100057095 | Buje 6.2X8.5X3.5 + 14X1.5         | 3     |
|      |                                   |                 |                  | 6  | ZT1244100006000 | Goma Tope Patente                 | 1     |
|      |                                   |                 |                  | 7  |                 |                                   |       |
|      |                                   |                 |                  | 8  |                 |                                   |       |
|      |                                   |                 |                  | 9  |                 |                                   |       |
| 40   | PLACA ZONTES                      |                 |                  | 1  | ZT1210201362000 | Placa Publicitaria Trasera Zontes | 1     |
|      |                                   |                 |                  | 2  | ZT1251100102000 | Bulon M6X16 (No Std)              | 2     |
|      |                                   |                 |                  | 3  | ZT1250303010093 | Tuerca M6                         | 2     |
|      |                                   |                 |                  | 4  |                 |                                   |       |
|      |                                   |                 |                  | 5  |                 |                                   |       |
|      |                                   |                 |                  | 6  |                 |                                   |       |
|      |                                   |                 |                  | 7  |                 |                                   |       |
|      |                                   |                 |                  | 8  |                 |                                   |       |
|      |                                   |                 |                  | 9  |                 |                                   |       |

| FIG. | NOMBRE                   | IMAGEN CONJUNTO  | IMAGEN DE PARTES  | Nº | CÓDIGO          | DESCRIPCIÓN                       | CANT. |
|------|--------------------------|--|---|----|-----------------|-----------------------------------|-------|
| 41   | SOPORTES INTERNO GRIS    |   |   | 1  | ZT1141200049051 | Soporte Interno Izquierdo Gris    | 1     |
|      |                          |  |   | 2  | ZT1141200050051 | Soporte Interno Derecho Gris      | 1     |
|      |                          |  |   | 3  | ZT1251100060000 | Bulon M10X1.5X80                  | 2     |
|      |                          |  |   | 4  | ZT1251300057093 | Tuerca M10X1.5                    | 2     |
|      |                          |  |   | 5  | ZT1250105042091 | Bulon M8x75                       | 2     |
|      |                          |  |   | 6  | ZT1250305002091 | Tuerca M8                         | 2     |
|      |                          |  |   | 7  |                 |                                   |       |
|      |                          |  |   | 8  |                 |                                   |       |
|      |                          |  |   | 9  |                 |                                   |       |
| 42   | SOPORTES INTERNO TITANIO |  |  | 1  | ZT1141200053035 | Soporte Interno Izquierdo Titanio | 1     |
|      |                          |  |   | 2  | ZT1141200054035 | Soporte Interno Derecho Titanio   | 1     |
|      |                          |  |   | 3  | ZT1251100060000 | Bulon M10X1.5X80                  | 2     |
|      |                          |  |   | 4  | ZT1251300057093 | Tuerca M10X1.5                    | 2     |
|      |                          |  |   | 5  | ZT1250105042091 | Bulón M8x75                       | 2     |
|      |                          |  |   | 6  | ZT1250305002091 | Tuerca M8                         | 2     |
|      |                          |  |   | 7  |                 |                                   |       |
|      |                          |  |   | 8  |                 |                                   |       |
|      |                          |  |   | 9  |                 |                                   |       |

| FIG. | NOMBRE           | IMAGEN CONJUNTO  | IMAGEN DE PARTES  | Nº | CÓDIGO          | DESCRIPCIÓN                    | CANT. |
|------|------------------|--|---|----|-----------------|--------------------------------|-------|
| 43   | DEFENSAS GRIS    |   |   | 1  | ZT1141200048051 | Defensa Derecha Gris           | 1     |
|      |                  |  |   | 2  | ZT1141200047051 | Defensa Izquierda Gris         | 1     |
|      |                  |  |   | 3  | ZT1244100061000 | Tapon De Cuadro                | 2     |
|      |                  |  |   | 4  | ZT1251100142000 | Bulon M10x1,5x130 (No Std)     | 2     |
|      |                  |  |   | 5  | ZT1244100089000 | Tope Protección Anti-Caída     | 2     |
|      |                  |  |   | 6  | ZT1241200056000 | Goma Protectora Defensa        | 2     |
|      |                  |  |   | 7  | ZT4024200027000 | Soporte Defensas Laterales Inf | 1     |
|      |                  |  |   | 8  | ZT1251112001093 | Bulon M6X16                    | 4     |
|      |                  |  |   | 9  |                 |                                |       |
| 44   | DEFENSAS TITANIO |  |  | 1  | ZT1141200052035 | Defensa Derecha Titanio        | 1     |
|      |                  |  |   | 2  | ZT1141200051035 | Defensa Izquierda Titanio      | 1     |
|      |                  |  |   | 3  | ZT1244100061000 | Tapon De Cuadro                | 2     |
|      |                  |  |   | 4  | ZT1251100142000 | Bulon M10x1,5x130 (No Std)     | 2     |
|      |                  |  |   | 5  | ZT1244100089000 | Tope Protección Anti-Caída     | 2     |
|      |                  |  |   | 6  | ZT1241200056000 | Goma Protectora Defensa        | 2     |
|      |                  |  |   | 7  | ZT4024200027000 | Soporte Defensas Laterales Inf | 1     |
|      |                  |  |   | 8  | ZT1251112001093 | Bulon M6X16                    | 4     |
|      |                  |  |   | 9  |                 |                                |       |

| FIG. | NOMBRE                   | IMAGEN CONJUNTO  | IMAGEN DE PARTES  |   |   | Nº | CÓDIGO          | DESCRIPCIÓN                 | CANT. |
|------|--------------------------|--|---|---|---|----|-----------------|-----------------------------|-------|
| 45   | SOPORTE INFERIOR DEFENSA |   |  |  |  | 1  | ZT4021200021000 | Soporte Inferior Defensas   | 1     |
|      |                          |  |   |   |   | 2  | ZT1251100132003 | Bulon M10X1.5X80            | 1     |
|      |                          |  |   |   |   | 3  | ZT1251300057093 | Tuerca M10X1.5              | 1     |
|      |                          |  |   |   |   | 4  |                 |                             |       |
|      |                          |  |   |   |   | 5  |                 |                             |       |
|      |                          |  |   |   |   | 6  |                 |                             |       |
|      |                          |  |   |   |   | 7  |                 |                             |       |
|      |                          |  |   |   |   | 8  |                 |                             |       |
|      |                          |  |   |   |   | 9  |                 |                             |       |
| 46   | MANUBRIO                 |  |  |  |  | 1  | ZT1134200008000 | Manubrio                    | 1     |
|      |                          |  |   |   |   | 2  | ZT1184200184000 | Comando Luces Izquierdo     | 1     |
|      |                          |  |   |   |   | 3  | ZT1244100041000 | Puño Izquierdo              | 1     |
|      |                          |  |   |   |   | 4  | ZT1184200185000 | Comando Luces Derecho       | 1     |
|      |                          |  |   |   |   |    | ZT1151200049000 | Cable Acelerador Abre       | 1     |
|      |                          |  |   |   |   |    | ZT1151200048000 | Cable Acelerador Cierra     | 1     |
|      |                          |  |   |   |   | 7  | ZT1244100042000 | Puño Acelerador             | 1     |
|      |                          |  |   |   |   | 8  | ZT1251100219000 | Bulón Cabeza Esférica M5X30 | 2     |
|      |                          |  |   |   |   | 9  |                 |                             |       |

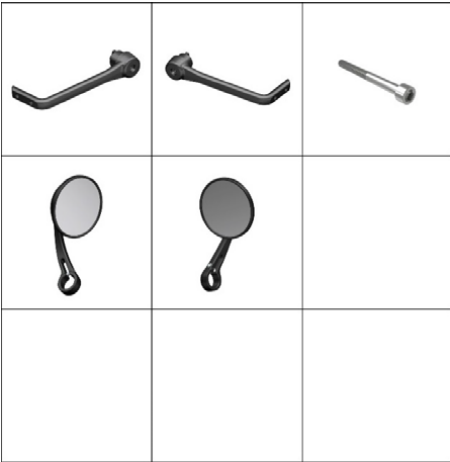
| FIG. | NOMBRE  | IMAGEN CONJUNTO  | IMAGEN DE PARTES  | Nº | CÓDIGO          | DESCRIPCIÓN                  | CANT. |
|------|---------|--|---|----|-----------------|------------------------------|-------|
| 47   | ESPEJOS |  |  | 1  | ZT1131200026000 | Protector de Mano Izquierdo  | 1     |
|      |         |  |   | 2  | ZT1131200027000 | Protector de Mano Derecho    | 1     |
|      |         |  |   | 3  | ZT1250205085000 | Bulon Gb70.1M6x7             | 2     |
|      |         |  |   | 4  | ZT1190100426000 | Espejo Izquierdo (Extendido) | 1     |
|      |         |  |   | 5  | ZT1190100427000 | Espejo Derecho (Extendido)   | 1     |
|      |         |  |   | 6  |                 |                              |       |
|      |         |  |   | 7  |                 |                              |       |
|      |         |  |   | 8  |                 |                              |       |
|      |         |  |   | 9  |                 |                              |       |
|      |         |  |   |    |                 |                              |       |
|      |         |  |   |    |                 |                              |       |

| FIG. | NOMBRE              | IMAGEN CONJUNTO | IMAGEN DE PARTES | Nº | CÓDIGO          | DESCRIPCIÓN                         | CANT. |
|------|---------------------|-----------------|------------------|----|-----------------|-------------------------------------|-------|
| 48   | COMANDO DE EMBRAGUE |                 |                  | 1  | ZT1134200011000 | Soporte Base Espejo Y Leva Izq      | 1     |
|      |                     |                 |                  | 2  | ZT1134200010000 | Leva De Embrague                    | 1     |
|      |                     |                 |                  | 3  | ZT1251100198000 | Bulon M6x13 - Ø8x20                 | 1     |
|      |                     |                 |                  | 4  | ZT1251300073000 | Tuerca M6                           | 1     |
|      |                     |                 |                  | 5  | ZT1134100017000 | Brida Soporte Leva Embrague         | 1     |
|      |                     |                 |                  | 6  | ZT1251100121093 | Bulon M8X25                         | 2     |
|      |                     |                 |                  | 7  | ZT1184200170000 | Bulbo de Embrague                   | 1     |
|      |                     |                 |                  | 8  | ZT1250201039000 | Bulon M4X12                         | 1     |
|      |                     |                 |                  | 9  | ZT1244200046000 | Conector Cable De Embrague          | 1     |
|      |                     |                 |                  | 10 | ZT1154100011000 | Cable de Embrague                   | 1     |
|      |                     |                 |                  | 11 | ZT1244100095000 | Goma Porta Espejos                  | 1     |
|      |                     |                 |                  | 12 | ZT1134200017000 | Kit Leva Embrague c/ Soporte Espejo | 1     |
|      |                     |                 |                  |    |                 |                                     |       |
|      |                     |                 |                  |    |                 |                                     |       |
|      |                     |                 |                  |    |                 |                                     |       |
|      |                     |                 |                  |    |                 |                                     |       |

| FIG. | NOMBRE                 | IMAGEN CONJUNTO | IMAGEN DE PARTES | Nº | CÓDIGO          | DESCRIPCIÓN                               | CANT. |
|------|------------------------|-----------------|------------------|----|-----------------|---|-------|
| 49   | BRIDA SOPORTE MANUBRIO |                 |                  | 1  | ZT1134200005000 | Brida Superior Manubrio                   | 1     |
|      |                        |                 |                  | 2  | ZT1224100025000 | Tapa Cubre Bulon Brida Sup. Manubrio      | 4     |
|      |                        |                 |                  | 3  | ZT1250205023000 | Bulon M8X35 Allen                         | 4     |
|      |                        |                 |                  | 4  | ZT4094200002051 | Brida Inferior Manubrio M10x1,25          | 2     |
|      |                        |                 |                  | 5  | ZT1274200018000 | Arandela Fijación Brida Inferior Manubrio | 4     |
|      |                        |                 |                  | 6  | ZT1244200008000 | Buje Goma Fijación Brida Manubrio         | 4     |
|      |                        |                 |                  | 7  | ZT1251700065000 | Buje 10X12X41                             | 2     |
|      |                        |                 |                  | 8  | ZT1250105280000 | Bulón M10x60                              | 2     |
|      |                        |                 |                  | 9  |                 |   |       |
|      |                        |                 |                  |    |                 |   |       |
|      |                        |                 |                  |    |                 |   |       |
|      |                        |                 |                  |    |                 |   |       |
|      |                        |                 |                  |    |                 |   |       |
|      |                        |                 |                  |    |                 |   |       |
|      |                        |                 |                  |    |                 |   |       |
|      |                        |                 |                  |    |                 |   |       |
|      |                        |                 |                  |    |                 |   |       |









| FIG. | NOMBRE                | IMAGEN CONJUNTO | IMAGEN DE PARTES | Nº | CÓDIGO          | DESCRIPCIÓN                     | CANT. |
|------|-----------------------|-----------------|------------------|----|-----------------|---------------------------------|-------|
| 50   | BOMBA FRENO DELANTERO |                 |                  | 1  | ZT1100300044000 | Bomba Freno Delantero           | 1     |
|      |                       |                 |                  | 2  | ZT1134100032000 | Leva Freno Delantero            | 1     |
|      |                       |                 |                  | 3  | ZT1134100019000 | Brida Bomba Freno Delantero     | 1     |
|      |                       |                 |                  | 4  | ZT1251100121093 | Bulon M8X25                     | 2     |
|      |                       |                 |                  | 5  | ZT1251100112000 | Bulon Flexible Freno M10X1X22   | 1     |
|      |                       |                 |                  | 6  | ZT1251513013000 | Arandela Cobre 10.2x15x1.5      | 2     |
|      |                       |                 |                  | 7  | ZT1100100092000 | Pastilla Freno Trasero Hs10     | 1     |
|      |                       |                 |                  | 8  | ZT1100100704000 | Pastilla Freno Delantero SF627  | 1     |
|      |                       |                 |                  | 9  | ZT1244100095000 | Goma Porta Espejos              | 1     |
|      |                       |                 |                  | 10 | ZT1100100570000 | Placa Soporte Caliper Delantero | 1     |
|      |                       |                 |                  | 11 | ZT1100100571000 | Placa Soporte Caliper Delantero | 1     |
|      |                       |                 |                  | 12 | ZT1100100583000 | Bulbo Freno Delantero           | 1     |
|      |                       |                 |                  |    |                 |                                 |       |
|      |                       |                 |                  |    |                 |                                 |       |
|      |                       |                 |                  |    |                 |                                 |       |
|      |                       |                 |                  |    |                 |                                 |       |









| FIG. | NOMBRE                           | IMAGEN CONJUNTO | IMAGEN DE PARTES | Nº | CÓDIGO          | DESCRIPCIÓN                      | CANT. |
|------|----------------------------------|-----------------|------------------|----|-----------------|----------------------------------|-------|
| 51   | SOPORTE FLEXIBLE FRENO DELANTERO |                 |                  | 1  | ZT1271200100000 | Soporte Flexible Freno Delantero | 1     |
|      |                                  |                 |                  | 2  | ZT1251100061093 | Bulon M6X22                      | 2     |
|      |                                  |                 |                  | 3  | ZT1251100080094 | Bulon M8X37                      | 2     |
|      |                                  |                 |                  | 4  | ZT1251100112000 | Bulon Flexible Freno M10X1X22    | 2     |
|      |                                  |                 |                  | 5  | ZT1251513013000 | Arandela Cobre 10.2x15x1.5       | 6     |
|      |                                  |                 |                  | 6  | ZT1251100121093 | Bulon M8X25                      | 2     |
|      |                                  |                 |                  | 7  |                 |                                  |       |
|      |                                  |                 |                  | 8  |                 |                                  |       |
|      |                                  |                 |                  | 9  |                 |                                  |       |
| 52   | SOPORTE DE ABS PIEZA 1           |                 |                  | 1  | ZT1271200193021 | Soporte de ABS (Pieza 1)         | 1     |
|      |                                  |                 |                  | 2  | ZT1251100102000 | Bulon M6X16 (No Std)             | 1     |
|      |                                  |                 |                  | 3  | ZT1251112001093 | Bulon M6X16                      | 2     |
|      |                                  |                 |                  | 4  | ZT1274100007000 | Buje                             | 1     |
|      |                                  |                 |                  | 5  | ZT1244100004000 | Goma Silent-Block                | 1     |
|      |                                  |                 |                  | 6  | ZT1251100101000 | Bulon M6X12 (No Std)             | 1     |
|      |                                  |                 |                  | 7  | ZT1271200192000 | Buje Soporte ABS                 | 1     |
|      |                                  |                 |                  | 8  | ZT1241200070000 | Goma Silent-Block                | 1     |
|      |                                  |                 |                  | 9  |                 |                                  |       |

| FIG. | NOMBRE                | IMAGEN CONJUNTO | IMAGEN DE PARTES | Nº | CÓDIGO          | DESCRIPCIÓN                 | CANT. |
|------|-----------------------|-----------------|------------------|----|-----------------|-----------------------------|-------|
| 53   | COBERTOR EXTERIOR ABS |                 |                  | 1  | ZT1020412093000 | Cobertor Exterior ABS       | 1     |
|      |                       |                 |                  | 2  | ZT1251100102000 | Bulon M6X16 (No Std)        | 1     |
|      |                       |                 |                  | 3  | ZT1244100052000 | Arandela Goma 8.5X14X1      | 1     |
|      |                       |                 |                  | 4  | ZT1274100057095 | Buje 6.2X8.5X3.5 + 14X1.5   | 1     |
|      |                       |                 |                  | 5  | ZT1241200062000 | Goma con Adhesivo (50x15x2) | 3     |
|      |                       |                 |                  | 6  | ZT1251100248000 | Bulón Hexagonal M10x20      | 4     |
|      |                       |                 |                  | 7  | ZT1251513013000 | Arandela Cobre 10.2x15x1.5  | 8     |
|      |                       |                 |                  | 8  |                 |                             |       |
|      |                       |                 |                  | 9  |                 |                             |       |
| 54   | CABEZAL HORQUILLAS    |                 |                  | 1  | ZT1251300045000 | Tuerca Sup. Caño Vela       | 1     |
|      |                       |                 |                  | 2  | ZT1251500050000 | Arandela Sup. Caño Vela     | 1     |
|      |                       |                 |                  | 3  | ZT1134200004000 | Cabezal Horquilla           | 1     |
|      |                       |                 |                  | 4  | ZT1250205023000 | Bulon M8X35 Allen           | 2     |
|      |                       |                 |                  | 5  | ZT1181200101000 | Llave Contacto Completa     | 1     |
|      |                       |                 |                  | 6  | ZT1251100121093 | Bulon M8X25                 | 2     |
|      |                       |                 |                  | 7  |                 |                             |       |
|      |                       |                 |                  | 8  |                 |                             |       |
|      |                       |                 |                  | 9  |                 |                             |       |

| FIG. | NOMBRE                    | IMAGEN CONJUNTO                            | IMAGEN DE PARTES | Nº | CÓDIGO          | DESCRIPCIÓN                        | CANT. |
|------|---------------------------|--|------------------|----|-----------------|------------------------------------|-------|
| 55   | CRISTO CON CAÑO VELA      |  |                  | 1  | ZT1134100015000 | Cristo Con Caño Vela               | 1     |
|      |                           |  |                  | 2  | ZT1134100007000 | Junta Blockqueo Tuerca Caño Vela   | 1     |
|      |                           |  |                  | 3  | ZT1251300046093 | Tuerca Caño Vela M24X1             | 2     |
|      |                           |  |                  | 4  | ZT1244100015000 | Junta De Tuerca Ajuste             | 1     |
|      |                           |  |                  | 5  | ZT1224100005000 | Guardapolvo Superior Caño Vela     | 1     |
|      |                           |  |                  | 6  | ZT1130900024000 | Pista Superior                     | 1     |
|      |                           |  |                  | 7  | ZT1130900022000 | Anillo Esferas                     | 2     |
|      |                           |  |                  | 8  | ZT1224100006000 | Guardapolvo Inferior Caño Vela     | 1     |
|      |                           |  |                  | 9  | ZT1250205023000 | Bulon M8X35 Allen                  | 4     |
| 56   | SUSPENSION DELANTERA (YA) | <p>ZT*****G/GYA<br/>年/月/日<br/>YY/MM/DD</p> |                  | 1  | ZT1111200036000 | Horquilla Delantera Izquierda (YA) | 1     |
|      |                           |  |                  | 2  | ZT1111200037000 | Horquilla Delantera Derecha (YA)   | 1     |
|      |                           |  |                  | 3  | ZT1250205023000 | Bulon M8X35 Allen                  | 4     |
|      |                           |  |                  | 4  | ZT1174100001000 | Ojo Gato Horquillas                | 2     |
|      |                           |  |                  | 5  | ZT1094100033000 | Eje Delantero                      | 1     |
|      |                           |  |                  | 6  | ZT1094100008000 | Distanciador Izq. Eje Delantero    | 1     |
|      |                           |  |                  | 7  | ZT1094100036000 | Buje Der. Eje Delantero            | 1     |
|      |                           |  |                  | 8  | ZT1094100037000 | Buje Fij. Der. Eje Delantero       | 1     |
|      |                           |  |                  | 9  | ZT1244200035000 | Reten Horquilla Delantera          | 2     |







| FIG. | NOMBRE                                    | IMAGEN CONJUNTO | IMAGEN DE PARTES | Nº | CÓDIGO          | DESCRIPCIÓN                      | CANT. |
|------|---|-----------------|------------------|----|-----------------|----------------------------------|-------|
| 57   | RUEDA DELANTERA RAYOS INTERIOR CON CAMARA |                 |                  | 1  | ZT1091200026000 | Llanta Delantera Rayos Interior  | 1     |
|      |   |                 |                  | 2  | ZT1230100186000 | Protector de Cámara              | 1     |
|      |   |                 |                  | 3  | ZT1230200006000 | Tapón Valvula Llanta             | 1     |
|      |   |                 |                  | 4  | ZT1230100456000 | Cubierta (110 / 70-17)           | 1     |
|      |   |                 |                  | 5  | ZT1100100601000 | Disco de Freno Delantero         | 1     |
|      |   |                 |                  | 6  | ZT1251100117093 | Bulon M8X25                      | 5     |
|      |   |                 |                  | 7  | ZT1230100470000 | Camara 17                        | 1     |
|      |   |                 |                  | 8  | ZT1244200135000 | Reten 28x42x7                    | 2     |
|      |   |                 |                  | 9  | ZT1250601119000 | Rodamiento 6004-2RS-C3           | 2     |
| 58   | SENSOR ABS DELANTERO                      |                 |                  | 1  | ZT1274200058000 | Disco Sistema ABS 60 DIENTE      | 1     |
|      |   |                 |                  | 2  | ZT1251100117093 | Bulon M8X25                      | 5     |
|      |   |                 |                  |    | ZT1181200118000 | Sensor Velocidad Abs (A)         | 1     |
|      |   |                 |                  | 4  | ZT1251100101000 | Bulon M6X12 (No Std)             | 2     |
|      |   |                 |                  | 5  | ZT1224200127000 | Grampa Frontal Cable Sensor Vel. | 1     |
|      |   |                 |                  | 6  | ZT1224100044000 | Grampa Cable Sensor Velocidad    | 3     |
|      |   |                 |                  | 7  |                 |                                  |       |
|      |   |                 |                  | 8  |                 |                                  |       |
|      |   |                 |                  | 9  |                 |                                  |       |

| FIG. | NOMBRE             | IMAGEN CONJUNTO  | IMAGEN DE PARTES  |   |   | Nº | CÓDIGO          | DESCRIPCIÓN              | CANT. |
|------|--------------------|--|---|---|---|----|-----------------|--------------------------|-------|
| 59   | HORQUILLON GRIS    |   |  |  |  | 1  | ZT4021200037000 | Horquilla Gris           | 1     |
|      |                    |  |   |   |   | 2  | ZT1250602035000 | Rodamiento Agujas Hk2516 | 4     |
|      |                    |  |   |   |   | 3  | ZT1244200079000 | Retén Ø25xØ32x4          | 4     |
|      |                    |  | 4   | ZT1271200088000   | Buje Horquilla  | 2  |                 |                          |       |
|      |                    |  | 5   | ZT1252200068000   | Eje Horquilla   | 1  |                 |                          |       |
|      |                    |  | 6   | ZT1251300067000   | Tuerca Eje Trasero  | 1  |                 |                          |       |
|      |                    |  | 7   |   |   |    |                 |                          |       |
|      |                    |  | 8   |   |   |    |                 |                          |       |
|      |                    |  | 9   |   |   |    |                 |                          |       |
| 60   | HORQUILLON TITANIO |  |  |  |  | 1  | ZT4021200032000 | Horquilla Titanio        | 1     |
|      |                    |  |   |   |   | 2  | ZT1250602035000 | Rodamiento Agujas Hk2516 | 4     |
|      |                    |  |   |   |   | 3  | ZT1244200079000 | Retén Ø25xØ32x4          | 4     |
|      |                    |  | 4   | ZT1271200088000   | Buje Horquilla  | 2  |                 |                          |       |
|      |                    |  | 5   | ZT1252200068000   | Eje Horquilla   | 1  |                 |                          |       |
|      |                    |  | 6   | ZT1251300067000   | Tuerca Eje Trasero  | 1  |                 |                          |       |
|      |                    |  | 7   |   |   |    |                 |                          |       |
|      |                    |  | 8   |   |   |    |                 |                          |       |
|      |                    |  | 9   |   |   |    |                 |                          |       |

| FIG. | NOMBRE               | IMAGEN CONJUNTO  | IMAGEN DE PARTES   |   |   | Nº | CÓDIGO          | DESCRIPCIÓN                  | CANT. |  |
|------|----------------------|--|--|---|---|----|-----------------|------------------------------|-------|--|
| 61   | GUIA CADENA          |   |   |  |  | 1  | ZT1244200053000 | Guía Cadena Superior         | 1     |  |
|      |                      |  |  |   |   | 2  | ZT1271200062000 | Soporte Guía Cadena Superior | 1     |  |
|      |                      |  |  |   |   | 3  | ZT1274100057095 | Buje 6.2X8.5X3.5 + 14X1.5    | 2     |  |
|      |                      |  | 4  | ZT1251100102000   | Bulon M6X16 (No Std)  | 4  |                 |                              |       |  |
|      |                      |  | 5  |   |   |    |                 |                              |       |  |
|      |                      |  | 6  |   |   |    |                 |                              |       |  |
|      |                      |  | 7  |   |   |    |                 |                              |       |  |
|      |                      |  | 8  |   |   |    |                 |                              |       |  |
|      |                      |  | 9  |   |   |    |                 |                              |       |  |
| 62   | AMORTIGUADOR TRASERO |  |  |  |  | 1  | ZT1114200007000 | Amortiguador Trasero         | 1     |  |
|      |                      |  |  |   |   | 2  | ZT1251100085093 | Bulon M10X1.5X75             | 1     |  |
|      |                      |  |  |   |   | 3  | ZT1251100132003 | Bulon M10X1.5X80             | 1     |  |
|      |                      |  | 4  | ZT1251300057093   | Tuerca M10X1.5  | 2  |                 |                              |       |  |
|      |                      |  | 5  |   |   |    |                 |                              |       |  |
|      |                      |  | 6  |   |   |    |                 |                              |       |  |
|      |                      |  | 7  |   |   |    |                 |                              |       |  |
|      |                      |  | 8  |   |   |    |                 |                              |       |  |
|      |                      |  | 9  |   |   |    |                 |                              |       |  |









| FIG. | NOMBRE                            | IMAGEN CONJUNTO | IMAGEN DE PARTES | Nº | CÓDIGO          | DESCRIPCIÓN                               | CANT. |
|------|-----------------------------------|-----------------|------------------|----|-----------------|---|-------|
| 63   | GUARDABARRO INTERIOR CUBRE CADENA |                 |                  | 1  | ZT1221200040000 | Guardabarro Interior Cubre Cadena         | 1     |
|      |                                   |                 |                  | 2  | ZT1271200068000 | Soporte Guardabarro Interior Cubre Cadena | 1     |
|      |                                   |                 |                  | 3  | ZT1251100102000 | Bulon M6X16 (No Std)                      | 2     |
|      |                                   |                 |                  | 4  | ZT1251100101000 | Bulon M6X12 (No Std)                      | 1     |
|      |                                   |                 |                  | 5  | ZT1274100057095 | Buje 6.2X8.5X3.5 + 14X1.5                 | 1     |
|      |                                   |                 |                  | 6  | ZT1244100052000 | Arandela Goma 8.5X14X1                    | 2     |
|      |                                   |                 |                  | 7  | ZT1251700059093 | Buje 6.4X9X8 + 18X2                       | 1     |
|      |                                   |                 |                  | 8  | ZT1210342449000 | Calco Cubre Cadena                        | 1     |
|      |                                   |                 |                  | 9  |                 |   |       |
| 64   | ESTIRA CADENA GRIS                |                 |                  | 1  | ZT1032142074051 | Estira Cadena Izquierdo (Gris)            | 1     |
|      |                                   |                 |                  | 2  | ZT1032142075051 | Estira Cadena Derecho (Gris)              | 1     |
|      |                                   |                 |                  | 3  | ZT1251100105000 | Bulon M10X70                              | 2     |
|      |                                   |                 |                  | 4  | ZT1251300050000 | Tuerca M10                                | 2     |
|      |                                   |                 |                  | 5  |                 |   |       |
|      |                                   |                 |                  | 6  |                 |   |       |
|      |                                   |                 |                  | 7  |                 |   |       |
|      |                                   |                 |                  | 8  |                 |   |       |
|      |                                   |                 |                  | 9  |                 |   |       |

| FIG. | NOMBRE                | IMAGEN CONJUNTO | IMAGEN DE PARTES |                 |                               | Nº | CÓDIGO          | DESCRIPCIÓN                       | CANT. |  |
|------|-----------------------|-----------------|------------------|-----------------|-------------------------------|----|-----------------|-----------------------------------|-------|--|
| 65   | ESTIRA CADENA TIRANIO |                 |                  |                 |                               | 1  | ZT1032142072035 | Estira Cadena Izquierdo (Titanio) | 1     |  |
|      |                       |                 |                  |                 |                               | 2  | ZT1032142073035 | Estira Cadena Derecho (Titanio)   | 1     |  |
|      |                       |                 |                  |                 |                               | 3  | ZT1251100105000 | Bulon M10X70                      | 2     |  |
|      |                       |                 | 4                | ZT1251300050000 | Tuerca M10                    | 2  |                 |                                   |       |  |
|      |                       |                 | 5                |                 |                               |    |                 |                                   |       |  |
|      |                       |                 | 6                |                 |                               |    |                 |                                   |       |  |
|      |                       |                 | 7                |                 |                               |    |                 |                                   |       |  |
|      |                       |                 | 8                |                 |                               |    |                 |                                   |       |  |
|      |                       |                 | 9                |                 |                               |    |                 |                                   |       |  |
| 66   | TRANSMISION           |                 |                  |                 |                               | 1  | ZT1094200011000 | Porta Corona Versión 2            | 1     |  |
|      |                       |                 |                  |                 |                               | 2  | ZT1080100116000 | Corona 520-44T                    | 1     |  |
|      |                       |                 |                  |                 |                               | 3  | ZT1080200100000 | Cadena 112 / 520                  | 1     |  |
|      |                       |                 | 4                | ZT1251300057093 | Tuerca M10X1.5                | 5  |                 |                                   |       |  |
|      |                       |                 | 5                | ZT1244200050000 | Manchón Corona Version 2      | 5  |                 |                                   |       |  |
|      |                       |                 | 6                | ZT1094100035000 | Distanciador Izq. Eje Trasero | 1  |                 |                                   |       |  |
|      |                       |                 | 7                | ZT1250601124000 | Rodamiento 6205-2RS-C0        | 1  |                 |                                   |       |  |
|      |                       |                 | 8                | ZT1244200140000 | Reten 30x52x7                 | 1  |                 |                                   |       |  |
|      |                       |                 | 9                |                 |                               |    |                 |                                   |       |  |

| FIG. | NOMBRE                                  | IMAGEN CONJUNTO  | IMAGEN DE PARTES  | Nº | CÓDIGO          | DESCRIPCIÓN                           | CANT. |
|------|---|--|---|----|-----------------|---------------------------------------|-------|
| 67   | RUEDA TRASERA RAYOS INTERIOR CON CAMARA |   |    | 1  | ZT1091200027000 | Llanta Trasera Rayos INT              | 1     |
|      |   |  |   | 2  | ZT1230100455000 | Cubierta 130 / 70 - 17                | 1     |
|      |   |  |   | 3  | ZT1230100186000 | Elastico Protector de Cámara          | 1     |
|      |   |  |   | 4  | ZT1230200006000 | Tapón Valvula Llanta                  | 1     |
|      |   |  |   | 5  | ZT1100100600000 | Disco Freno Trasero 230 MM            | 1     |
|      |   |  |   | 6  | ZT1091200025000 | Eje Trasero                           | 1     |
|      |   |  |   | 7  | ZT1274200002000 | Buje Der. Rueda Trasera 20X28X38X18.5 | 1     |
|      |   |  |   | 8  | ZT1251300067000 | Tuerca Eje Trasero                    | 1     |
|      |   |  |   | 9  | ZT1230100236000 | Tubo Interno 130 / 70 -17             | 1     |
| 68   | RETEN Y RODAMIENTO DE RUEDA             |  |     | 1  | ZT1246200013000 | Reten 28x47x7                         | 2     |
|      |   |  |   | 2  | ZT1250601114000 | Rodamiento 6204-2R-C3                 | 2     |
|      |   |  |   | 3  |                 |                                       |       |
|      |   |  |   | 4  |                 |                                       |       |
|      |   |  |   | 5  |                 |                                       |       |
|      |   |  |   | 6  |                 |                                       |       |
|      |   |  |   | 7  |                 |                                       |       |
|      |   |  |   | 8  |                 |                                       |       |
|      |   |  |   | 9  |                 |                                       |       |

| FIG. | NOMBRE             | IMAGEN CONJUNTO           | IMAGEN DE PARTES | Nº | CÓDIGO          | DESCRIPCIÓN                   | CANT. |
|------|--------------------|---------------------------|------------------|----|-----------------|-------------------------------|-------|
| 69   | SENSOR ABS TRASERO |                           |                  | 1  | ZT1274200058000 | Disco Sistema ABS 60 DIENTE   | 1     |
|      |                    |                           |                  | 2  | ZT1251100117093 | Bulon M8X25                   | 5     |
|      |                    |                           |                  | 3  | ZT1184200045000 | Sensor Velocidad Abs          | 1     |
|      |                    |                           |                  | 4  | ZT1181200118000 | Sensor Velocidad Abs (A)      |       |
|      |                    |                           |                  | 5  | ZT1224200003000 | Grampa Flexible Freno Trasero | 2     |
|      |                    |                           |                  | 6  | ZT1224100044000 | Grampa Cable Sensor Velocidad | 2     |
|      |                    |                           |                  | 7  | ZT1251100101000 | Bulon M6X12 (No Std)          | 1     |
|      |                    |                           |                  | 8  | ZT1251100102000 | Bulon M6X16 (No Std)          | 2     |
|      |                    |                           |                  | 9  |                 |                               |       |
| 70   | CUADRO E5          | <p>旧款 Old      新款 New</p> |                  | 1  | ZT4011200054000 | Cuadro Completo (EV-2)        | 1     |
|      |                    |                           |                  | 2  | ZT1130900026000 | Cubeta Cuadro                 | 2     |
|      |                    |                           |                  | 3  | ZT1251100086093 | Bulon M10x1.5x112             | 1     |
|      |                    |                           |                  | 4  | ZT1251300057093 | Tuerca M10X1.5                | 1     |
|      |                    |                           |                  | 5  | ZT1244100002000 | Silent-Block Cachas Tanque    | 6     |
|      |                    |                           |                  | 6  | ZT1244100061000 | Tapon De Cuadro               | 6     |
|      |                    |                           |                  | 7  | ZT1240100023000 | Protector Borne De Batería    | 1     |
|      |                    |                           |                  | 8  | ZT1241200044000 | Goma Tope Tanque Combustible  | 2     |
|      |                    |                           |                  | 9  | ZT1240300007000 | Goma Silent-Block Batería     | 1     |
|      |                    |                           |                  | 10 | ZT1221200131000 | Soporte Plastico Cuadro       | 1     |









| FIG. | NOMBRE                   | IMAGEN CONJUNTO | IMAGEN DE PARTES | Nº | CÓDIGO          | DESCRIPCIÓN                            | CANT. |
|------|--------------------------|-----------------|------------------|----|-----------------|--|-------|
| 71   | INSTALACION ELECTRICA E5 |                 |                  | 1  | ZT1181200120000 | Instalacion Electrica Completa (A)     | 1     |
|      |                          |                 |                  | 2  | ZT1184100017000 | Relé Inyección Electronica Combustible | 6     |
|      |                          |                 |                  | 3  | ZT1184100002000 | Interruptor De Descarga                | 1     |
|      |                          |                 |                  | 4  | ZT1244100082000 | Capuchón De Interruptor De Descarga    | 1     |
|      |                          |                 |                  | 5  | ZT1184200039000 | Destellador                            | 1     |
|      |                          |                 |                  | 6  | ZT1224100051000 | Precintos 2.5X10                       | 4     |
|      |                          |                 |                  | 7  | ZT1224100037000 | Precintos 3.6X295                      | 31    |
|      |                          |                 |                  | 8  |                 |  |       |
|      |                          |                 |                  | 9  |                 |  |       |
|      |                          |                 |                  | 10 | ZT1184200127000 | Fusible 10A                            | 7     |
|      |                          |                 |                  | 11 | ZT1184200128000 | Fusible 15A                            | 6     |
|      |                          |                 |                  | 12 | ZT1184200129000 | Fusible 25A                            | 3     |
|      |                          |                 |                  | 13 |                 |  |       |
|      |                          |                 |                  | 14 |                 |  |       |
|      |                          |                 |                  | 15 |                 |  |       |
|      |                          |                 |                  | 16 |                 |  |       |
|      |                          |                 |                  | 17 |                 |  |       |
|      |                          |                 |                  | 18 |                 |  |       |





| FIG. | NOMBRE                         | IMAGEN CONJUNTO  | IMAGEN DE PARTES   |   |   | Nº | CÓDIGO          | DESCRIPCIÓN                    | CANT. |  |
|------|--------------------------------|--|--|---|---|----|-----------------|--------------------------------|-------|--|
| 72   | REGULADOR TENSION TAPA GRIS    |   |  |  |  | 1  | ZT4041201119051 | Tapa Regulador Tension Gris    | 1     |  |
|      |                                |  |  |   |   | 2  | ZT1251112003093 | Bulon M6X45                    | 2     |  |
|      |                                |  |  |   |   | 3  | ZT1251700146000 | Buje 12x6x26.5                 | 2     |  |
|      |                                |  | 4  | ZT1181200085000   | Regulador Tension   | 1  |                 |                                |       |  |
|      |                                |  | 5  |   |   |    |                 |                                |       |  |
|      |                                |  | 6  |   |   |    |                 |                                |       |  |
|      |                                |  | 7  |   |   |    |                 |                                |       |  |
|      |                                |  | 8  |   |   |    |                 |                                |       |  |
|      |                                |  | 9  |   |   |    |                 |                                |       |  |
| 73   | REGULADOR TENSION TAPA TITANIO |  |  |  |  | 1  | ZT4041201077051 | Tapa Regulador Tension Titanio | 1     |  |
|      |                                |  |  |   |   | 2  | ZT1251112003093 | Bulon M6X45                    | 2     |  |
|      |                                |  |  |   |   | 3  | ZT1251700146000 | Buje 12x6x26.5                 | 2     |  |
|      |                                |  | 4  | ZT1181200085000   | Regulador Tension   | 1  |                 |                                |       |  |
|      |                                |  | 5  |   |   |    |                 |                                |       |  |
|      |                                |  | 6  |   |   |    |                 |                                |       |  |
|      |                                |  | 7  |   |   |    |                 |                                |       |  |
|      |                                |  | 8  |   |   |    |                 |                                |       |  |
|      |                                |  | 9  |   |   |    |                 |                                |       |  |

| FIG. | NOMBRE  | IMAGEN CONJUNTO | IMAGEN DE PARTES | Nº | CÓDIGO          | DESCRIPCIÓN                              | CANT. |
|------|---|-----------------|------------------|----|-----------------|--|-------|
| 74   | ECU EURO 5/ RELE ARRANQUE / CERRADURA ASIENTO |                 |                  | 1  | ZT1050956015000 | ECU MSE6                                 | 1     |
|      |   |                 |                  | 2  | ZT1271200080000 | Soporte ECU                              | 1     |
|      |   |                 |                  | 3  | ZT1251100120093 | Bulón M6x12                              | 2     |
|      |   |                 |                  | 4  | ZT1251100119093 | Bulon M6X12                              | 2     |
|      |   |                 |                  | 5  | ZT1274100058000 | Cerradura Electronica Asiento            | 1     |
|      |   |                 |                  | 6  | ZT1251100101000 | Bulon M6X12 (No Std)                     | 3     |
|      |   |                 |                  | 7  | ZT1184100010000 | Relé Arranque                            | 1     |
|      |   |                 |                  | 8  | ZT1050954009000 | Electrovalvula Tanque Filtro Combustible | 1     |
|      |   |                 |                  | 9  | ZT1250303010093 | Tuerca M6                                | 1     |
| 75   | BOBINA EXTERNA / BOCINA                       |                 |                  | 1  | ZT1186200014000 | Bobina Externa                           | 1     |
|      |   |                 |                  | 2  | ZT1250201032093 | Bulon M5X16                              | 2     |
|      |   |                 |                  | 3  | ZT1221200058000 | Soporte Bobina Externa                   | 1     |
|      |   |                 |                  | 4  | ZT1251112001093 | Bulon M6X16                              | 3     |
|      |   |                 |                  | 5  | ZT1184200004000 | Bocina                                   | 1     |
|      |   |                 |                  | 6  | ZT1050968009000 | Bujia                                    | 1     |
|      |   |                 |                  | 7  |                 |  |       |
|      |   |                 |                  | 8  |                 |  |       |
|      |   |                 |                  | 9  |                 |  |       |





| FIG. | NOMBRE               | IMAGEN CONJUNTO | IMAGEN DE PARTES | Nº | CÓDIGO          | DESCRIPCIÓN              | CANT. |
|------|----------------------|-----------------|------------------|----|-----------------|--------------------------|-------|
| 76   | INTERRUPTOR DE MOTOR |                 |                  | 1  | ZT1184100012000 | Interruptor De Motor     | 1     |
|      |                      |                 |                  | 2  | ZT1250205040095 | Bulon M8X16              | 2     |
|      |                      |                 |                  | 3  | ZT1224100037000 | Precintos 3.6X295        | 2     |
|      |                      |                 |                  | 4  | ZT1274100095000 | Pasacable De Interruptor | 1     |
|      |                      |                 |                  | 5  |                 |                          |       |
|      |                      |                 |                  | 6  |                 |                          |       |
|      |                      |                 |                  | 7  |                 |                          |       |
|      |                      |                 |                  | 8  |                 |                          |       |
|      |                      |                 |                  | 9  |                 |                          |       |
| 77   | SOPORTES DE MOTOR    |                 |                  | 1  | ZT4021200053021 | Soporte Motor Izquierdo  | 1     |
|      |                      |                 |                  | 2  | ZT4021200054021 | Soporte Motor Derecho    | 1     |
|      |                      |                 |                  | 3  | ZT1250105017091 | Bulón M8x65              | 2     |
|      |                      |                 |                  | 4  | ZT1250305002091 | Tuerca M8                | 2     |
|      |                      |                 |                  | 5  | ZT4021200029000 | Soporte Central Cuadro   | 1     |
|      |                      |                 |                  | 6  | ZT1251100085093 | Bulon M10X1.5X75         | 2     |
|      |                      |                 |                  | 7  | ZT1251300057093 | Tuerca M10X1.5           | 2     |
|      |                      |                 |                  | 8  |                 |                          |       |
|      |                      |                 |                  | 9  |                 |                          |       |



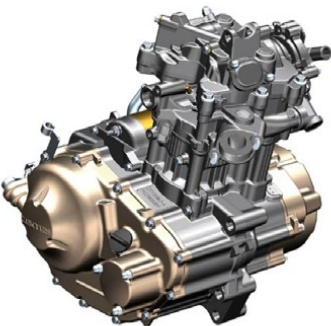

| FIG. | NOMBRE                 | IMAGEN CONJUNTO | IMAGEN DE PARTES | Nº | CÓDIGO          | DESCRIPCIÓN            | CANT. |
|------|------------------------|-----------------|------------------|----|-----------------|------------------------|-------|
| 78   | SOSTEN LATERAL GRIS    |                 |                  | 1  | ZT1271200165000 | Sosten Lateral Gris    | 1     |
|      |                        |                 |                  | 2  | ZT1251100088094 | Bulon M10x1.5x43       | 1     |
|      |                        |                 |                  | 3  | ZT1264100001000 | Resorte Sosten Lateral | 1     |
|      |                        |                 |                  | 4  | ZT1251700025091 | Buje De Sosten Lateral | 1     |
|      |                        |                 |                  | 5  | ZT1251300057093 | Tuerca M10X1.5         | 1     |
|      |                        |                 |                  | 6  |                 |                        |       |
|      |                        |                 |                  | 7  |                 |                        |       |
|      |                        |                 |                  | 8  |                 |                        |       |
|      |                        |                 |                  | 9  |                 |                        |       |
| 79   | SOSTEN LATERAL TITANIO |                 |                  | 1  | ZT1274200200000 | Sosten Lateral Titanio | 1     |
|      |                        |                 |                  | 2  | ZT1251100088094 | Bulon M10x1.5x43       | 1     |
|      |                        |                 |                  | 3  | ZT1264100001000 | Resorte Sosten Lateral | 1     |
|      |                        |                 |                  | 4  | ZT1251700025091 | Buje De Sosten Lateral | 1     |
|      |                        |                 |                  | 5  | ZT1251300057093 | Tuerca M10X1.5         | 1     |
|      |                        |                 |                  | 6  |                 |                        |       |
|      |                        |                 |                  | 7  |                 |                        |       |
|      |                        |                 |                  | 8  |                 |                        |       |
|      |                        |                 |                  | 9  |                 |                        |       |

| FIG. | NOMBRE                      | IMAGEN CONJUNTO  | IMAGEN DE PARTES  |  |   | Nº | CÓDIGO          | DESCRIPCIÓN                          | CANT. |
|------|-----------------------------|--|---|--|---|----|-----------------|--------------------------------------|-------|
| 80   | CAJA FILTRO AIRE            |   |   |    |  | 1  | ZT1221200033000 | Caja Filtro Aire                     | 1     |
|      |                             |  |   |  |   | 2  | ZT1251300063093 | Grampa M6X11X15                      | 3     |
|      |                             |  |   |  |   | 3  | ZT1251100101000 | Bulon M6X12 (No Std)                 | 3     |
|      |                             |  |   |  |   | 4  | ZT1051356012000 | Abrazadera Caja Filtro Aire (42x10)  | 1     |
|      |                             |  |   |  |   | 5  | ZT1221200125000 | Canister                             | 1     |
|      |                             |  |   |  |   | 6  | ZT4131200001000 | Filtro Aire                          | 1     |
|      |                             |  |   |  |   | 7  |                 |                                      |       |
|      |                             |  |   |  |   | 8  |                 |                                      |       |
|      |                             |  |   |  |   | 9  |                 |                                      |       |
| 81   | SEPARADOR DE ACEITE Y GASES |  |  |  |  | 1  | ZT4041201332000 | Separador de Aceite y Gases Externos | 1     |
|      |                             |  |   |  |   | 2  | ZT1224100037000 | Precintos 3.6X295                    | 1     |
|      |                             |  |   |  |   | 3  | ZT1051754001000 | Buje 10x5,5x6                        | 1     |
|      |                             |  |   |  |   | 4  | ZT1220100201000 | Valvula Canister                     | 2     |
|      |                             |  |   |  |   | 5  | ZT1270100021000 | Ánillo de Seguridad (1x7)            | 1     |
|      |                             |  |   |  |   | 6  |                 |                                      |       |
|      |                             |  |   |  |   | 7  |                 |                                      |       |
|      |                             |  |   |  |   | 8  |                 |                                      |       |
|      |                             |  |   |  |   | 9  |                 |                                      |       |





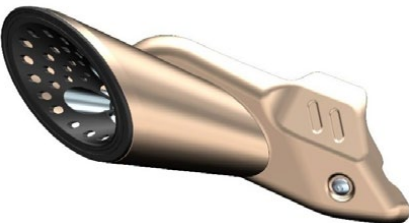

| FIG. | NOMBRE                  | IMAGEN CONJUNTO  | IMAGEN DE PARTES  | Nº | CÓDIGO          | DESCRIPCIÓN                             | CANT. |
|------|-------------------------|--|---|----|-----------------|---|-------|
| 82   | CUERPO DE INYECCIÓN A   |   |   | 1  | ZT1050956018000 | Cuerpo de Inyeccion A                   | 1     |
|      |                         |  |   | 2  | ZT1050956005000 | Motor Paso a Paso                       | 1     |
|      |                         |  |   | 3  | ZT1050954024000 | Sensor Tres en Uno                      | 1     |
|      |                         |  |   | 4  |                 |   |       |
|      |                         |  |   | 5  |                 |   |       |
|      |                         |  |   | 6  |                 |   |       |
|      |                         |  |   | 7  |                 |   |       |
|      |                         |  |   | 8  |                 |   |       |
|      |                         |  |   | 9  |                 |   |       |
| 83   | ACOPLE CUERPO INYECCIÓN |  |  | 1  | ZT1050956004000 | Acople Cuerpo Inyeccion                 | 1     |
|      |                         |  |   | 2  | ZT1051468007000 | O'ring Goma 31,8x2                      | 1     |
|      |                         |  |   | 3  | ZT1050956010000 | Manguera de Alta Presión de Combustible | 1     |
|      |                         |  |   | 4  | ZT1251112001093 | Bulon M6X16                             | 2     |
|      |                         |  |   | 5  | ZT1050968002000 | Capuchon de Inyector                    | 1     |
|      |                         |  |   | 6  | ZT1250105138093 | Bulon M6x20                             | 1     |
|      |                         |  |   | 7  | ZT1050968003000 | Inyector Combustible                    | 1     |
|      |                         |  |   | 8  | ZT1051356010000 | Abrazadera Cuerpo Inyector (45x10)      | 1     |
|      |                         |  |   | 9  |                 |   |       |









| FIG. | NOMBRE                                 | IMAGEN CONJUNTO | IMAGEN DE PARTES |  |  | Nº | CÓDIGO          | DESCRIPCIÓN              | CANT. |  |
|------|--|-----------------|------------------|--|--|----|-----------------|--------------------------|-------|--|
| 84   | TERMOSTATO Y REGULADOR TENSIÓN GRIS    |                 |                  |  |  | 1  | ZT1051956001000 | Termostato Compl         | 1     |  |
|      |  |                 |                  |  |  | 2  | ZT1051468010000 | O'ring 16,5x1,95         | 1     |  |
|      |  |                 |                  |  |  | 3  | ZT1251100061093 | Bulon M6X22              | 2     |  |
|      |  |                 |                  |  |  | 4  | ZT1050954026000 | Sonda Lambda             | 1     |  |
|      |  |                 |                  |  |  | 5  | ZT4050856002051 | Tapa Cubre Piñon Gris    | 1     |  |
|      |  |                 |                  |  |  | 6  | ZT1251112002093 | Bulon M6X30              | 2     |  |
|      |  |                 | 7                |  |  |    |                 |                          |       |  |
|      |  |                 | 8                |  |  |    |                 |                          |       |  |
|      |  |                 | 9                |  |  |    |                 |                          |       |  |
| 85   | TERMOSTATO Y REGULADOR TENSIÓN TITANIO |                 |                  |  |  | 1  | ZT1051956001000 | Termostato Compl         | 1     |  |
|      |  |                 |                  |  |  | 2  | ZT1051468010000 | O'ring 16,5x1,95         | 1     |  |
|      |  |                 |                  |  |  | 3  | ZT1251100061093 | Bulon M6X22              | 2     |  |
|      |  |                 |                  |  |  | 4  | ZT1050954026000 | Sonda Lambda             | 1     |  |
|      |  |                 |                  |  |  | 5  | ZT4050856001051 | Tapa Cubre Piñon Titanio | 1     |  |
|      |  |                 |                  |  |  | 6  | ZT1251112002093 | Bulon M6X30              | 2     |  |
|      |  |                 | 7                |  |  |    |                 |                          |       |  |
|      |  |                 | 8                |  |  |    |                 |                          |       |  |
|      |  |                 | 9                |  |  |    |                 |                          |       |  |

| FIG. | NOMBRE             | IMAGEN CONJUNTO  | IMAGEN DE PARTES  | Nº | CÓDIGO          | DESCRIPCIÓN                          | CANT. |
|------|--------------------|--|---|----|-----------------|--------------------------------------|-------|
| 86   | MOTOR COMPLETO     |   |   | 1  | ZT5560101024051 | Motor Completo Gris                  | 1     |
|      |                    |  |   | 2  | ZT5560101022051 | Motor Completo Titanio               | 1     |
|      |                    |  |   | 3  |                 |                                      |       |
|      |                    |  |   | 4  |                 |                                      |       |
|      |                    |  |   | 5  |                 |                                      |       |
|      |                    |  |   | 6  |                 |                                      |       |
|      |                    |  |   | 7  |                 |                                      |       |
|      |                    |  |   | 8  |                 |                                      |       |
|      |                    |  |   | 9  |                 |                                      |       |
| 87   | CATALIZADOR EURO 5 |  |  | 1  | ZT4081200001000 | Salida Escape con Catalizador Euro V | 1     |
|      |                    |  |   | 2  | ZT1251300058093 | Tuerca M8 Tubo Salida Escape         | 2     |
|      |                    |  |   | 3  | ZT1070100202000 | Junta de Escape                      | 1     |
|      |                    |  |   | 4  | ZT1250105021091 | Bulón M8x90                          | 1     |
|      |                    |  |   | 5  | ZT1241200045000 | Goma Salida Escape                   | 2     |
|      |                    |  |   | 6  | ZT1251900055093 | Buje Salida Escape                   | 1     |
|      |                    |  |   | 7  | ZT1274100068095 | Buje Fij. Catalizador                | 1     |
|      |                    |  |   | 8  | ZT1250303011093 | Tuerca M8                            | 1     |
|      |                    |  |   | 9  |                 |                                      |       |

| FIG. | NOMBRE              | IMAGEN CONJUNTO  | IMAGEN DE PARTES  | Nº | CÓDIGO          | DESCRIPCIÓN                         | CANT. |
|------|---------------------|--|---|----|-----------------|-------------------------------------|-------|
| 88   | SILENCIADOR GRIS    |   |   | 1  | ZT1032112022051 | Protector Calor Silenciador Gris    | 1     |
|      |                     |  |   | 2  | ZT1250501010000 | Grower 6                            | 5     |
|      |                     |  |   | 3  | ZT1251100102000 | Bulon M6X16 (No Std)                | 3     |
|      |                     |  |   | 4  | ZT1251100101000 | Bulon M6X12 (No Std)                | 2     |
|      |                     |  |   | 5  | ZT1032112023051 | Tubo Ext. Silenciador Gris          | 1     |
|      |                     |  |   | 6  | ZT1032112014000 | Rejilla Int. Silenciador            | 1     |
|      |                     |  |   | 7  |                 |                                     |       |
|      |                     |  |   | 8  |                 |                                     |       |
|      |                     |  |   | 9  |                 |                                     |       |
| 89   | SILENCIADOR TITANIO |  |  | 1  | ZT1032112012000 | Protector Calor Silenciador Titanio | 1     |
|      |                     |  |   | 2  | ZT1250501010000 | Grower 6                            | 5     |
|      |                     |  |   | 3  | ZT1251100102000 | Bulon M6X16 (No Std)                | 3     |
|      |                     |  |   | 4  | ZT1251100101000 | Bulon M6X12 (No Std)                | 2     |
|      |                     |  |   | 5  | ZT1032112013000 | Tubo Ext. Silenciador Titanio       | 1     |
|      |                     |  |   | 6  | ZT1032112014000 | Rejilla Int. Silenciador            | 1     |
|      |                     |  |   | 7  |                 |                                     |       |
|      |                     |  |   | 8  |                 |                                     |       |
|      |                     |  |   | 9  |                 |                                     |       |

| FIG. | NOMBRE                            | IMAGEN CONJUNTO | IMAGEN DE PARTES | Nº | CÓDIGO          | DESCRIPCIÓN                                   | CANT. |
|------|-----------------------------------|-----------------|------------------|----|-----------------|---|-------|
| 90   | SOPORTE IZQUIERDO PEDALIN GRIS    | <p>新款 New</p>   |                  | 1  | ZT4061200003051 | Soporte Izq. Pedalín Acomp. Reforzado Gris    | 1     |
|      |                                   |                 |                  | 2  | ZT1250205023000 | Bulon M8X35 Allen                             | 2     |
|      |                                   |                 |                  | 3  | ZT1250205040095 | Bulon M8X16                                   | 1     |
|      |                                   |                 |                  | 4  | ZT4061200007000 | Pedalín Acomp. Izq. Reforzado Gris            | 1     |
|      |                                   |                 |                  | 5  | ZT1260100301000 | Resorte Esfera Posición Pedalín               | 1     |
|      |                                   |                 |                  | 6  | ZT1274300031000 | Esfera Poción Pedalín Acompañante             | 1     |
|      |                                   |                 |                  | 7  | ZT1274300032000 | Placa Posición Pedalín                        | 1     |
|      |                                   |                 |                  | 8  | ZT1274300033000 | Perno Pedalín                                 | 1     |
|      |                                   |                 |                  | 9  | ZT1264100006000 | Seguer E                                      | 1     |
| 91   | SOPORTE IZQUIERDO PEDALIN TITANIO | <p>新款 New</p>   |                  | 1  | ZT4061200001035 | Soporte Izq. Pedalín Acomp. Titanio Reforzado | 1     |
|      |                                   |                 |                  | 2  | ZT1250205023000 | Bulon M8X35 Allen                             | 2     |
|      |                                   |                 |                  | 3  | ZT1250205040095 | Bulon M8X16                                   | 1     |
|      |                                   |                 |                  | 4  | ZT4064300019051 | Pedalín acompañante izq Reforzado Titanio     | 1     |
|      |                                   |                 |                  | 5  | ZT1260100301000 | Resorte Esfera Posición Pedalín               | 1     |
|      |                                   |                 |                  | 6  | ZT1274300031000 | Esfera Poción Pedalín Acompañante             | 1     |
|      |                                   |                 |                  | 7  | ZT1274300032000 | Placa Posición Pedalín                        | 1     |
|      |                                   |                 |                  | 8  | ZT1274300033000 | Perno Pedalín                                 | 1     |
|      |                                   |                 |                  | 9  | ZT1264100006000 | Seguer E                                      | 1     |









| FIG. | NOMBRE                              | IMAGEN CONJUNTO   | IMAGEN DE PARTES  | Nº | CÓDIGO          | DESCRIPCIÓN                                 | CANT. |
|------|-------------------------------------|---|---|----|-----------------|---|-------|
| 92   | PEDALIN CONDUCTOR IZQUIERDO GRIS    | <br>    |   | 1  | ZT1271200195000 | Soporte Pedalín Reforzado Gris              | 1     |
|      |                                     |   |   | 2  | ZT1264100003000 | Resorte Pedalin Izquierdo                   | 1     |
|      |                                     |   |   | 3  | ZT4061200005000 | Pedalin Conductor Izq Reforzado Gris        | 1     |
|      |                                     |   |   | 4  | ZT1274300033000 | Perno Pedalin                               | 1     |
|      |                                     |   |   | 5  | ZT1264100006000 | Seguer E                                    | 1     |
|      |                                     |   |   | 6  | ZT1274200334000 | Arandela Soporte Pedalin                    | 1     |
|      |                                     |   |   | 7  | ZT1250105278093 | Bulón M10x25                                | 1     |
|      |                                     |   |   | 8  |                 |   |       |
|      |                                     |   |   | 9  |                 |   |       |
| 93   | PEDALIN CONDUCTOR IZQUIERDO TITANIO | <br> |  | 1  | ZT1271200191000 | Soporte Pedalin Conductor Reforzado Titanio | 1     |
|      |                                     |   |   | 2  | ZT1264100003000 | Resorte Pedalin Izquierdo                   | 1     |
|      |                                     |   |   | 3  | ZT4064300017051 | Pedalin Conductor Izq Reforzado Titanio     | 1     |
|      |                                     |   |   | 4  | ZT1274300033000 | Perno Pedalin                               | 1     |
|      |                                     |   |   | 5  | ZT1264100006000 | Seguer E                                    | 1     |
|      |                                     |   |   | 6  | ZT1274200334000 | Arandela Soporte Pedalin                    | 1     |
|      |                                     |   |   | 7  | ZT1250105278093 | Bulon M10x25                                | 1     |
|      |                                     |   |   | 8  |                 |   |       |
|      |                                     |   |   | 9  |                 |   |       |





| FIG. | NOMBRE                         | IMAGEN CONJUNTO  | IMAGEN DE PARTES  |   |   | Nº | CÓDIGO          | DESCRIPCIÓN                     | CANT. |
|------|--------------------------------|--|---|---|---|----|-----------------|---------------------------------|-------|
| 94   | LEVA COMANDO DE CAMBIOS GRIS   |   |  |  |  | 1  | ZT1271200163000 | Leva Comando De Cambios Gris    | 1     |
|      |                                |  |   |   |   | 2  | ZT1251100061093 | Bulon M6X22                     | 2     |
|      |                                |  |   |   |   | 3  | ZT1250303010093 | Tuerca M6                       | 1     |
|      |                                |  | 4   | ZT1274100042000   | Rotula Leva Comando De Cambio   | 1  |                 |                                 |       |
|      |                                |  | 5   | ZT1250301020093   | Tuerca M6   | 1  |                 |                                 |       |
|      |                                |  | 6   |   |   |    |                 |                                 |       |
|      |                                |  | 7   |   |   |    |                 |                                 |       |
|      |                                |  | 8   |   |   |    |                 |                                 |       |
|      |                                |  | 9   |   |   |    |                 |                                 |       |
| 95   | LEVA COMANDO DE CAMBIO TITANIO |  |  |  |  | 1  | ZT1274100039000 | Leva Comando De Cambios Titanio | 1     |
|      |                                |  |   |   |   | 2  | ZT1251100061093 | Bulon M6X22                     | 2     |
|      |                                |  |   |   |   | 3  | ZT1250303010093 | Tuerca M6                       | 1     |
|      |                                |  | 4   | ZT1274100042000   | Rotula Leva Comando De Cambio   | 1  |                 |                                 |       |
|      |                                |  | 5   | ZT1250301020093   | Tuerca M6   | 1  |                 |                                 |       |
|      |                                |  | 6   |   |   |    |                 |                                 |       |
|      |                                |  | 7   |   |   |    |                 |                                 |       |
|      |                                |  | 8   |   |   |    |                 |                                 |       |
|      |                                |  | 9   |   |   |    |                 |                                 |       |









| FIG. | NOMBRE                  | IMAGEN CONJUNTO | IMAGEN DE PARTES | Nº | CÓDIGO          | DESCRIPCIÓN             | CANT. |
|------|-------------------------|-----------------|------------------|----|-----------------|-------------------------|-------|
| 96   | PALANCA CAMBIOS GRIS    |                 |                  | 1  | ZT1271200162000 | Palanca Cambios Gris    | 1     |
|      |                         |                 |                  | 2  | ZT1250303010093 | Tuerca M6               | 1     |
|      |                         |                 |                  | 3  | ZT1251100061093 | Bulon M6X22             | 1     |
|      |                         |                 |                  | 4  | ZT1274100043000 | Rotula Palanca Cambios  | 1     |
|      |                         |                 |                  | 5  | ZT1250301018093 | Tuerca Hexagonal M6     | 1     |
|      |                         |                 |                  | 6  | ZT1271200086000 | Varilla Palanca Cambios | 1     |
|      |                         |                 |                  | 7  |                 |                         |       |
|      |                         |                 |                  | 8  |                 |                         |       |
|      |                         |                 |                  | 9  |                 |                         |       |
| 97   | PALANCA CAMBIOS TITANIO |                 |                  | 1  | ZT1274200160000 | Palanca Cambios Titanio | 1     |
|      |                         |                 |                  | 2  | ZT1250303010093 | Tuerca M6               | 1     |
|      |                         |                 |                  | 3  | ZT1251100061093 | Bulon M6X22             | 1     |
|      |                         |                 |                  | 4  | ZT1274100043000 | Rotula Palanca Cambios  | 1     |
|      |                         |                 |                  | 5  | ZT1250301018093 | Tuerca Hexagonal M6     | 1     |
|      |                         |                 |                  | 6  | ZT1271200086000 | Varilla Palanca Cambios | 1     |
|      |                         |                 |                  | 7  |                 |                         |       |
|      |                         |                 |                  | 8  |                 |                         |       |
|      |                         |                 |                  | 9  |                 |                         |       |



| FIG. | NOMBRE                          | IMAGEN CONJUNTO | IMAGEN DE PARTES | Nº | CÓDIGO          | DESCRIPCIÓN                                  | CANT. |
|------|---------------------------------|-----------------|------------------|----|-----------------|--|-------|
| 98   | SOPORTE DERECHO PEDALIN GRIS    |                 |                  | 1  | ZT4061200004051 | Soporte Pedalín Acomp Der. Reforzado Gris    | 1     |
|      |                                 |                 |                  | 2  | ZT1250205023000 | Bulon M8X35 Allen                            | 2     |
|      |                                 |                 |                  | 3  | ZT1250205040095 | Bulon M8X16                                  | 1     |
|      |                                 |                 |                  | 4  | ZT4061200008000 | Pedalín Conductor Der. Reforzado Gris        | 1     |
|      |                                 |                 |                  | 5  | ZT1260100301000 | Resorte Esfera Posición Pedalín              | 1     |
|      |                                 |                 |                  | 6  | ZT1274300031000 | Esfera Poción Pedalín Acompañante            | 1     |
|      |                                 |                 |                  | 7  | ZT1274300032000 | Placa Posición Pedalín                       | 1     |
|      |                                 |                 |                  | 8  | ZT1274300033000 | Perno Pedalín                                | 1     |
|      |                                 |                 |                  | 9  | ZT1264100006000 | Seguer E                                     | 1     |
| 99   | SOPORTE DERECHO PEDALIN TITANIO |                 |                  | 1  | ZT4061200002035 | Soporte Pedalín Acomp Der. Reforzado Titanio | 1     |
|      |                                 |                 |                  | 2  | ZT1250205023000 | Bulon M8X35 Allen                            | 2     |
|      |                                 |                 |                  | 3  | ZT1250205040095 | Bulon M8X16                                  | 1     |
|      |                                 |                 |                  | 4  | ZT4064300020051 | Pedalín Acomp Der Reforzado Titanio          | 1     |
|      |                                 |                 |                  | 5  | ZT1260100301000 | Resorte Esfera Posición Pedalín              | 1     |
|      |                                 |                 |                  | 6  | ZT1274300031000 | Esfera Poción Pedalín Acompañante            | 1     |
|      |                                 |                 |                  | 7  | ZT1274300032000 | Placa Posición Pedalín                       | 1     |
|      |                                 |                 |                  | 8  | ZT1274300033000 | Perno Pedalín                                | 1     |
|      |                                 |                 |                  | 9  | ZT1264100006000 | Seguer E                                     | 1     |

| FIG. | NOMBRE                            | IMAGEN CONJUNTO | IMAGEN DE PARTES | Nº | CÓDIGO          | DESCRIPCIÓN                              | CANT. |
|------|-----------------------------------|-----------------|------------------|----|-----------------|--|-------|
| 100  | PEDALIN CONDUCTOR DERECHO GRIS    | <br>            | <br>             | 1  | ZT406120006000  | Pedalin Conductor Derecho Reforzado Gris | 1     |
|      |                                   |                 |                  | 2  | ZT1264100004000 | Resorte Pedalin Derecho                  | 1     |
|      |                                   |                 |                  | 3  | ZT1274300033000 | Perno Pedalin                            | 1     |
|      |                                   |                 |                  | 4  | ZT1264100006000 | Seguer E                                 | 1     |
|      |                                   |                 |                  | 5  |                 |  |       |
|      |                                   |                 |                  | 6  |                 |  |       |
|      |                                   |                 |                  | 7  |                 |  |       |
|      |                                   |                 |                  | 8  |                 |  |       |
|      |                                   |                 |                  | 9  |                 |  |       |
| 101  | PEDALIN CONDUCTOR DERECHO TITANIO | <br>            | <br>             | 1  | ZT4064300018051 | Pedalin Conductor Der. Reforzado Titanio | 1     |
|      |                                   |                 |                  | 2  | ZT1264100004000 | Resorte Pedalin Derecho                  | 1     |
|      |                                   |                 |                  | 3  | ZT1274300033000 | Perno Pedalin                            | 1     |
|      |                                   |                 |                  | 4  | ZT1264100006000 | Seguer E                                 | 1     |
|      |                                   |                 |                  | 5  |                 |  |       |
|      |                                   |                 |                  | 6  |                 |  |       |
|      |                                   |                 |                  | 7  |                 |  |       |
|      |                                   |                 |                  | 8  |                 |  |       |
|      |                                   |                 |                  | 9  |                 |  |       |

| FIG. | NOMBRE                         | IMAGEN CONJUNTO  | IMAGEN DE PARTES  |   |   | Nº | CÓDIGO          | DESCRIPCIÓN                 | CANT. |
|------|--------------------------------|--|---|---|---|----|-----------------|-----------------------------|-------|
| 102  | PEDAL DE FRENO TRASERO GRIS    |   |  |  |  | 1  | ZT1271200164000 | Pedal Freno Trasero Gris    | 1     |
|      |                                |  |   |   |   | 2  | ZT1260100119093 | Resorte Pedal Freno Tras    | 1     |
|      |                                |  |   |   |   | 3  | ZT1251100131000 | Bulon M10X1.5X36            | 1     |
|      |                                |  | 4   | ZT1251500060095   | Arandela 10.5X26X1  | 1  |                 |                             |       |
|      |                                |  | 5   |   |   |    |                 |                             |       |
|      |                                |  | 6   |   |   |    |                 |                             |       |
|      |                                |  | 7   |   |   |    |                 |                             |       |
|      |                                |  | 8   |   |   |    |                 |                             |       |
|      |                                |  | 9   |   |   |    |                 |                             |       |
| 103  | PEDAL DE FRENO TRASERO TITANIO |  |  |  |  | 1  | ZT1271200085000 | Pedal Freno Trasero Titanio | 1     |
|      |                                |  |   |   |   | 2  | ZT1260100119093 | Resorte Pedal Freno Tras    | 1     |
|      |                                |  |   |   |   | 3  | ZT1251100131000 | Bulon M10X1.5X36            | 1     |
|      |                                |  | 4   | ZT1251500060095   | Arandela 10.5X26X1  | 1  |                 |                             |       |
|      |                                |  | 5   |   |   |    |                 |                             |       |
|      |                                |  | 6   |   |   |    |                 |                             |       |
|      |                                |  | 7   |   |   |    |                 |                             |       |
|      |                                |  | 8   |   |   |    |                 |                             |       |
|      |                                |  | 9   |   |   |    |                 |                             |       |

| FIG. | NOMBRE                         | IMAGEN CONJUNTO  | IMAGEN DE PARTES  |   |                 | Nº  | CÓDIGO | DESCRIPCIÓN | CANT. |
|------|--------------------------------|--|---|---|-----------------|---|--------|-------------|-------|
| 104  | SOPORTE FLEXIBLE FRENO TRASERO |   |   | 1 | ZT1271200087000 | Soporte Flexible Freno Trasero            | 1      |             |       |
|      |                                |  |   | 2 | ZT1251100101000 | Bulon M6X12 (No Std)                      | 1      |             |       |
|      |                                |  |   | 3 |                 |   |        |             |       |
|      |                                |  |   | 4 |                 |   |        |             |       |
|      |                                |  |   | 5 |                 |   |        |             |       |
|      |                                |  |   | 6 |                 |   |        |             |       |
|      |                                |  |   | 7 |                 |   |        |             |       |
|      |                                |  |   | 8 |                 |   |        |             |       |
|      |                                |  |   | 9 |                 |   |        |             |       |
| 105  | PEDALINES GRIS                 |  |  | 1 | ZT1244300013000 | Goma Pedalin Posapie (350T)               | 4      |             |       |
|      |                                |  |   | 2 | ZT1274200051000 | Placa De Goma Pedalin                     | 4      |             |       |
|      |                                |  |   | 3 | ZT1251100167000 | Bulon M6X8                                | 2      |             |       |
|      |                                |  |   | 4 | ZT1250205038000 | Bulon M5X12                               | 4      |             |       |
|      |                                |  |   | 5 | ZT4064300005051 | Soporte Pedalin Acompañante Der T350 Gris | 1      |             |       |
|      |                                |  |   | 6 | ZT4064300006051 | Soporte Pedalin Acompañante Izq T350 Gris | 1      |             |       |
|      |                                |  |   | 7 | ZT4064300007051 | Soporte Pedalin Conductor Izq T350 Gris   | 1      |             |       |
|      |                                |  |   | 8 | ZT4064300008051 | Soporte Pedalin Conductor Der T350 Gris   | 1      |             |       |
|      |                                |  |   | 9 | ZT1250501010000 | Grower 6                                  | 4      |             |       |

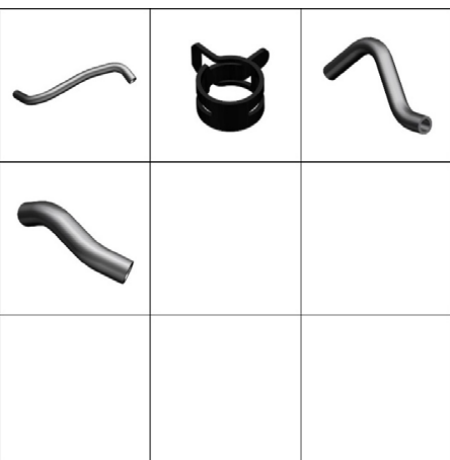
| FIG. | NOMBRE           | IMAGEN CONJUNTO  | IMAGEN DE PARTES   |   |   | Nº | CÓDIGO          | DESCRIPCIÓN                 | CANT. |
|------|------------------|--|--|---|---|----|-----------------|-----------------------------|-------|
| 106  | RADIADOR         |   |  |  |  | 1  | ZT1271200066000 | Radiador                    | 1     |
|      |                  |  |  |   |   | 2  | ZT1241200052000 | Codo Conexión Radiador-Tapa | 1     |
|      |                  |  |  |   |   | 3  | ZT1274200089000 | Abrazadera Clip 22          | 2     |
|      |                  |  |  |   |   | 4  | ZT1221200069000 | Tapa Radiador KD150         | 1     |
|      |                  |  |  |   |   | 5  | ZT1251100061093 | Bulon M6X22                 | 1     |
|      |                  |  |  |   |   | 6  | ZT1251100101000 | Bulon M6X12 (No Std)        | 1     |
|      |                  |  |  |   |   | 7  | ZT1251112002093 | Bulon M6X30                 | 2     |
|      |                  |  |  |   |   | 8  |                 |                             |       |
|      |                  |  |  |   |   | 9  |                 |                             |       |
| 107  | SOPORTE RADIADOR |  |   |  |  | 1  | ZT4021200024000 | Soporte Radiador            | 1     |
|      |                  |  |  |   |   | 2  | ZT1271200081000 | Soporte Cuadro - Radiador   | 1     |
|      |                  |  |  |   |   | 3  | ZT1251100061093 | Bulon M6X22                 | 2     |
|      |                  |  |  |   |   | 4  |                 |                             |       |
|      |                  |  |  |   |   | 5  |                 |                             |       |
|      |                  |  |  |   |   | 6  |                 |                             |       |
|      |                  |  |  |   |   | 7  |                 |                             |       |
|      |                  |  |  |   |   | 8  |                 |                             |       |
|      |                  |  |  |   |   | 9  |                 |                             |       |

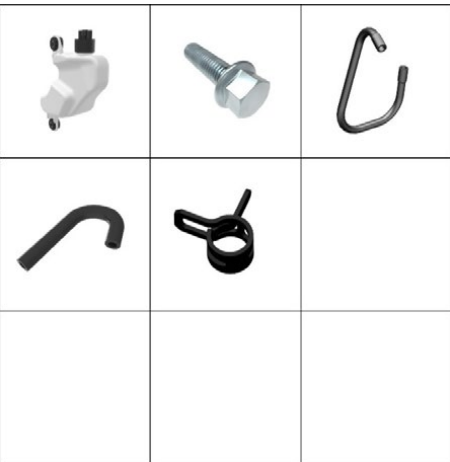
| FIG. | NOMBRE                  | IMAGEN CONJUNTO  | IMAGEN DE PARTES  | Nº | CÓDIGO          | DESCRIPCIÓN                       | CANT. |
|------|-------------------------|--|---|----|-----------------|-----------------------------------|-------|
| 108  | MANGUERAS RADIADOR      |   |   | 1  | ZT1241200055000 | Tubo Circulación Agua             | 1     |
|      |                         |  |   | 2  | ZT1274200089000 | Abrazadera Clip 22                | 6     |
|      |                         |  |   | 3  | ZT1241200053000 | Tubo Salida Motor                 | 1     |
|      |                         |  |   | 4  | ZT1241200054000 | Tubo Entrada Motor                | 1     |
|      |                         |  |   | 5  |                 |                                   |       |
|      |                         |  |   | 6  |                 |                                   |       |
|      |                         |  |   | 7  |                 |                                   |       |
|      |                         |  |   | 8  |                 |                                   |       |
|      |                         |  |   | 9  |                 |                                   |       |
| 109  | TANQUE DE AGUA AUXILIAR |  |  | 1  | ZT1221200050000 | Tanque de Agua Auxiliar           | 1     |
|      |                         |  |   | 2  | ZT1251100061093 | Bulon M6X22                       | 2     |
|      |                         |  |   | 3  | ZT1241200051000 | Tubo Tanque Agua Auxiliar         | 1     |
|      |                         |  |   | 4  | ZT1244200069000 | Tubo Drenaje Tanque Agua Auxiliar | 1     |
|      |                         |  |   | 5  | ZT1274200088000 | Abrazadera Clip 10.5              | 2     |
|      |                         |  |   | 6  |                 |                                   |       |
|      |                         |  |   | 7  |                 |                                   |       |
|      |                         |  |   | 8  |                 |                                   |       |
|      |                         |  |   | 9  |                 |                                   |       |





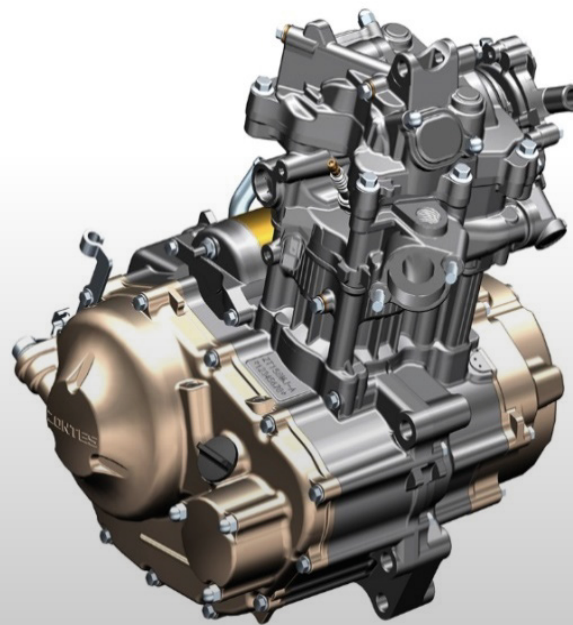

































CATÁLOGO DE PIEZAS DE REPUESTO  
**ZONTES | G1 - 155**

# MOTOR







| FIG. | NOMBRE           | IMAGEN CONJUNTO | IMAGEN DE PARTES | Nº | CÓDIGO          | DESCRIPCIÓN            | CANT. |
|------|------------------|-----------------|------------------|----|-----------------|------------------------|-------|
| 110  | BOMBA DE AGUA    |                 |                  | 1  |                 |                        | 1     |
|      |                  |                 |                  | 2  |                 |                        | 1     |
|      |                  |                 |                  | 3  | ZT4050656002000 | Bomba de Agua          | 1     |
|      |                  |                 |                  | 4  |                 |                        | 1     |
|      |                  |                 |                  | 5  |                 |                        |       |
|      |                  |                 |                  | 6  |                 |                        |       |
|      |                  |                 |                  | 7  |                 |                        |       |
|      |                  |                 |                  | 8  |                 |                        |       |
|      |                  |                 |                  | 9  |                 |                        |       |
| 111  | TAPA DE VALVÚLAS |                 |                  | 1  | ZT1251401001000 | Buje Posicionador 8X14 | 2     |
|      |                  |                 |                  | 2  | ZT1250101076093 | Bulon M8X45            | 4     |
|      |                  |                 |                  | 3  | ZT1251300096000 | Tuerca M6              | 4     |
|      |                  |                 |                  | 4  | ZT1051656001000 | Junta Tapa de Válvulas | 1     |
|      |                  |                 |                  | 5  | ZT1051456008000 | O-Ring 36x1.9 EPDM     | 2     |
|      |                  |                 |                  | 6  | ZT4050756008000 | Tapa de Válvulas (KIT) | 1     |
|      |                  |                 |                  | 7  | ZT1051156002000 | Tapa Inpección Válvula | 2     |
|      |                  |                 |                  | 8  | ZT1250101058093 | Bulon M8X25            | 1     |
|      |                  |                 |                  | 9  |                 |                        |       |



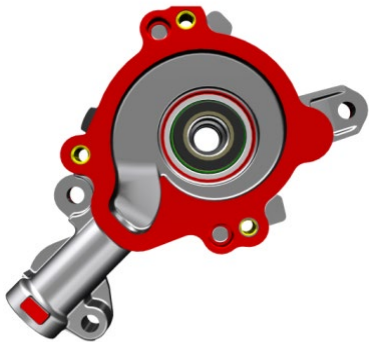
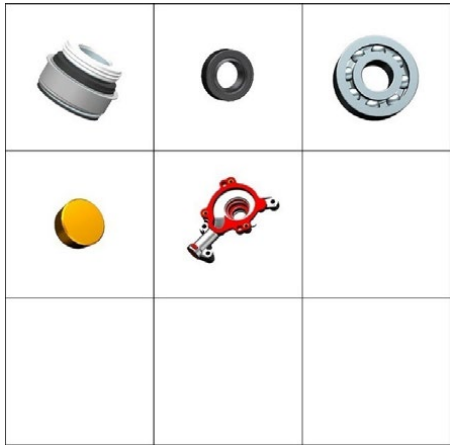
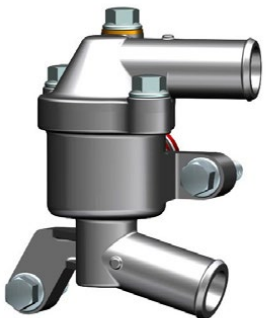
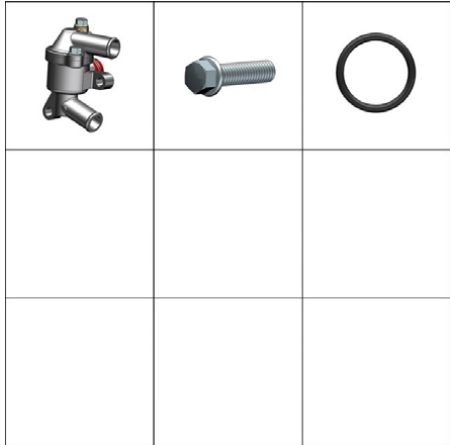



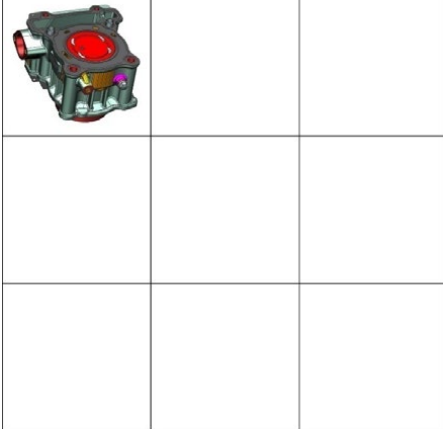

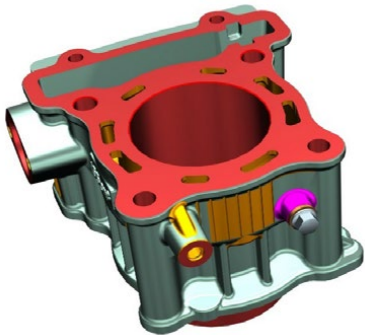

| FIG. | NOMBRE           | IMAGEN CONJUNTO | IMAGEN DE PARTES | Nº | CÓDIGO          | DESCRIPCIÓN               | CANT. |
|------|------------------|-----------------|------------------|----|-----------------|---------------------------|-------|
| 112  | TAPA DE VALVÚLAS |                 |                  | 1  | ZT1051754002000 | Perno Aceite 1.2X6X7      | 1     |
|      |                  |                 |                  | 2  | ZT1251111013000 | Esparrago M6X23.5         | 4     |
|      |                  |                 |                  | 3  | ZT1251112001093 | Bulon M6X16               | 1     |
|      |                  |                 |                  | 4  | ZT1251100067093 | Bulon M6X10               | 1     |
|      |                  |                 |                  | 5  | ZT1251513001019 | Arandela 6.3X12X1.6 Cobre | 2     |
|      |                  |                 |                  | 6  | ZT4050756002000 | Tapa de Válvulas (solo)   | 1     |
|      |                  |                 |                  | 7  |                 |                           |       |
|      |                  |                 |                  | 8  |                 |                           |       |
|      |                  |                 |                  | 9  |                 |                           |       |
| 113  | TAPA DE CILINDRO |                 |                  | 1  | ZT4050656005000 | Tapa Cilindro Completo    | 1     |
|      |                  |                 |                  | 2  | ZT1251112007093 | Bulon M6X105              | 2     |
|      |                  |                 |                  | 3  | ZT1251300080094 | Tuerca M8 (10°/Inox)      | 4     |
|      |                  |                 |                  | 4  | ZT1251500079000 | Junta Acero 8.3X18.2      | 4     |
|      |                  |                 |                  | 5  | ZT1251401003000 | Buje Posicionador 10X14   | 2     |
|      |                  |                 |                  | 6  |                 |                           |       |
|      |                  |                 |                  | 7  |                 |                           |       |
|      |                  |                 |                  | 8  |                 |                           |       |
|      |                  |                 |                  | 9  |                 |                           |       |

| FIG. | NOMBRE           | IMAGEN CONJUNTO   | IMAGEN DE PARTES  | Nº | CÓDIGO          | DESCRIPCIÓN                           | CANT. |
|------|------------------|---|---|----|-----------------|---------------------------------------|-------|
| 114  | TAPA DE CILINDRO | <br>  <p>旧款 Old      新款 New</p> <p>备注: 购买ZT1P58MJ进排气摇臂的用户, 请检查料件状态(如图所示), 旧状态用户则必须成对购买1050168-033000 ZT1P58MJ进排气摇臂分组件—B和1050168-034000 ZT1P58MJ排气摇臂分组件—B更换, 新款用户可自行下单购买。</p> |          | 1  | ZT4050656004000 | Tapa Cilindro (Solo)                  | 1     |
|      |                  |   |          | 2  | ZT1250601128000 | Rodamiento 6001/P5C3 GB276            | 1     |
|      |                  |   |          | 3  | ZT1050168033000 | Balancin Admisión                     | 1     |
|      |                  |   |          | 4  | ZT1050168034000 | Balancin Escape                       | 1     |
|      |                  |   |          | 5  | ZT1050168007000 | Eje de Balancin                       | 2     |
|      |                  |   |          | 6  | ZT1051368003000 | Placa Fijación Balancin               | 1     |
|      |                  |   |    | 7  | ZT1251111011000 | Esparrago M8X38                       | 2     |
|      |                  |   |    | 8  | ZT1251100067093 | Bulon M6X10                           | 2     |
|      |                  |   |    | 9  | ZT1051754002000 | Perno Aceite 1.2X6X7                  | 1     |
|      |                  |   |    | 10 | ZT1251201001094 | Bulon M5X15                           | 2     |
|      |                  |   |    | 11 | ZT1251513001019 | Arandela 6.3X12X1.6 Cobre             | 1     |
|      |                  |   |    | 12 | ZT1051553001000 | Retén Vavula 5.0                      | 4     |
|      |                  |   |    | 13 | ZT1051454009000 | O-Ring 9X2                            | 1     |
|      |                  |   |    | 14 | ZT1050954003000 | Sensor Aceite Y Agua + O-Ring         | 1     |
|      |                  |   |    | 15 | ZT1050968009000 | Bujía                                 | 1     |
|      |                  |   |    | 16 | ZT1050168011000 | Válvula Admisión                      | 2     |
|      |                  |   |    | 17 | ZT1050168012000 | Válvula Escape                        | 2     |
|      |                  |   |    | 18 | ZT1050168015000 | Plato Sup. Resort Válvulas            | 4     |
|      |                  |   |    | 19 | ZT1050168016000 | Seguro de Válvulas                    | 8     |
|      |                  |   |    | 20 | ZT1050168018000 | Base Inf. Resorte Válvula             | 4     |
|      |                  |   |    | 21 | ZT1051356015000 | Asiento Resorte Válvula 13.2x20.8x0.5 |       |
|      |                  |   |    | 22 | ZT1050168014000 | Resorte de Válvulas                   | 4     |
|      |                  |   |    | 23 | ZT1051468001000 | O-Ring 8.8x1.9                        | 1     |
|      |                  |   |    | 24 | ZT1050168023000 | Arbol de Levas                        | 1     |



| FIG. | NOMBRE                    | IMAGEN CONJUNTO            | IMAGEN DE PARTES | Nº  | CÓDIGO          | DESCRIPCIÓN              | CANT. |    |                 |                        |   |
|------|---------------------------|----------------------------|------------------|-----|-----------------|--------------------------|-------|----|-----------------|------------------------|---|
| 115  | TAPA DE CILINDRO COMPLETA |                            |                  | 1   | ZT4050656010000 | Tapa Cilindro C/Válvulas |       |    |                 |                        |   |
|      |                           |                            |                  | 2   |                 |                          |       |    |                 |                        |   |
|      |                           |                            |                  | 3   |                 |                          |       |    |                 |                        |   |
|      |                           |                            |                  | 4   |                 |                          |       |    |                 |                        |   |
|      |                           |                            |                  | 5   |                 |                          |       |    |                 |                        |   |
|      |                           |                            |                  | 6   |                 |                          |       |    |                 |                        |   |
|      |                           |                            |                  | 7   |                 |                          |       |    |                 |                        |   |
|      |                           |                            |                  | 8   |                 |                          |       |    |                 |                        |   |
|      |                           |                            |                  | 9   |                 |                          |       |    |                 |                        |   |
|      |                           |                            |                  | 116 | BOMBA DE AGUA   |                          |       | 10 | ZT1251401001000 | Buje Posicionador 8X14 | 4 |
|      |                           |                            |                  |     |                 |                          |       | 11 | ZT1051468011000 | O-Ring 18.2x2.4 EPDM   | 1 |
|      |                           |                            |                  |     |                 |                          |       | 12 | ZT1251112002093 | Bulon M6X30            | 3 |
| 13   | ZT1251100061093           | Bulon M6X22                | 4                |     |                 |                          |       |    |                 |                        |   |
| 14   | ZT1251513001019           | Arandela 6.3X12X1.6 Cobre  | 2                |     |                 |                          |       |    |                 |                        |   |
| 15   | ZT1251100067093           | Bulon M6X10                | 1                |     |                 |                          |       |    |                 |                        |   |
| 16   | ZT1051468013000           | Junta Tapa Bomba Agua      | 1                |     |                 |                          |       |    |                 |                        |   |
| 17   | ZT4050968001000           | Tapa Bomba Agua            | 1                |     |                 |                          |       |    |                 |                        |   |
| 18   | ZT4050956004000           | Kit Cuerpo Bomba Agua      | 1                |     |                 |                          |       |    |                 |                        |   |
| 19   | ZT1051656002000           | Guarnición Bomba Agua      | 1                |     |                 |                          |       |    |                 |                        |   |
| 20   | ZT1051968009000           | Eje Bomba Agua             | 1                |     |                 |                          |       |    |                 |                        |   |
| 21   | ZT1051968010000           | Turbina Bomba Agua         | 1                |     |                 |                          |       |    |                 |                        |   |
| 22   | ZT1051956002000           | Alivio de Bomba Agua       | 1                |     |                 |                          |       |    |                 |                        |   |
| 23   | ZT1250505015000           | Seguer 10                  | 1                |     |                 |                          |       |    |                 |                        |   |
| 24   | ZT1051956003000           | Manguera Alivio Bomba Agua | 1                |     |                 |                          |       |    |                 |                        |   |

| FIG. | NOMBRE              | IMAGEN CONJUNTO  | IMAGEN DE PARTES  | Nº | CÓDIGO          | DESCRIPCIÓN             | CANT. |
|------|---------------------|--|---|----|-----------------|-------------------------|-------|
| 117  | Bomba de Agua       |   |   | 1  | ZT1051954006000 | Reten De Agua           | 1     |
|      |                     |  |   | 2  | ZT1051568003000 | Reten 12x20x5           | 1     |
|      |                     |  |   | 3  | ZT1250601087000 | Rodamiento Gb-6000/P5C3 | 1     |
|      |                     |  |   | 4  | ZT1050868006000 | Block Agua 16.5x7.5     | 1     |
|      |                     |  |   | 5  | ZT1040956002000 | Cuerpo Bomba Agua       | 1     |
|      |                     |  |   | 6  |                 |                         |       |
|      |                     |  |   | 7  |                 |                         |       |
|      |                     |  |   | 8  |                 |                         |       |
|      |                     |  |   | 9  |                 |                         |       |
| 118  | TERMOSTATO COMPLETO |  |  | 1  | ZT1051956001000 | Termostato completo     | 1     |
|      |                     |  |   | 2  | ZT1251100061093 | Bulon M6X22             | 2     |
|      |                     |  |   | 3  | ZT1051468010000 | O'Ring 16.5x1.95        | 1     |
|      |                     |  |   | 4  |                 |                         |       |
|      |                     |  |   | 5  |                 |                         |       |
|      |                     |  |   | 6  |                 |                         |       |
|      |                     |  |   | 7  |                 |                         |       |
|      |                     |  |   | 8  |                 |                         |       |
|      |                     |  |   | 9  |                 |                         |       |

| FIG. | NOMBRE            | IMAGEN CONJUNTO  | IMAGEN DE PARTES  | Nº | CÓDIGO          | DESCRIPCIÓN             | CANT. |
|------|-------------------|--|---|----|-----------------|-------------------------|-------|
| 119  | CILINDRO COMPLETO |   |   | 1  |                 |                         | 1     |
|      |                   |  |   | 2  |                 |                         |       |
|      |                   |  |   | 3  |                 |                         |       |
|      |                   |  |   | 4  |                 |                         |       |
|      |                   |  |   | 5  |                 |                         |       |
|      |                   |  |   | 6  |                 |                         |       |
|      |                   |  |   | 7  |                 |                         |       |
|      |                   |  |   | 8  |                 |                         |       |
|      |                   |  |   | 9  |                 |                         |       |
| 120  | CILINDRO COMPLETO |  |  | 1  | ZT4050556011000 | Cilindro (S/Piston)     | 1     |
|      |                   |  |   | 2  | ZT1051668002000 | Junta Tapa Cilindro     | 1     |
|      |                   |  |   | 3  | ZT1050456004000 | Piston Completo         | 1     |
|      |                   |  |   | 4  | ZT1251401003000 | Buje Posicionador 10X14 | 2     |
|      |                   |  |   | 5  | ZT1051668003000 | Junta Cilindro-Carter   | 1     |
|      |                   |  |   | 6  |                 |                         |       |
|      |                   |  |   | 7  |                 |                         |       |
|      |                   |  |   | 8  |                 |                         |       |
|      |                   |  |   | 9  |                 |                         |       |

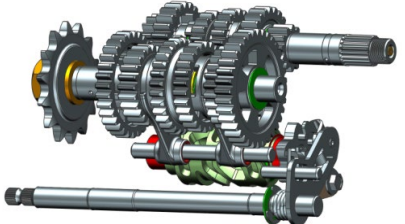
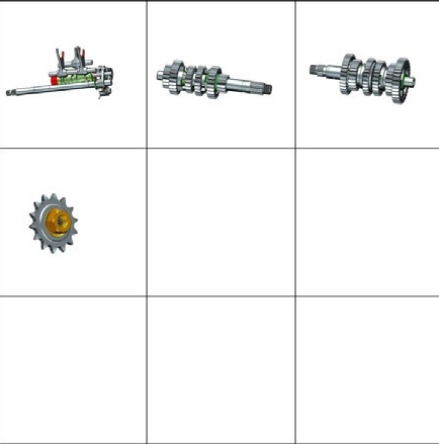
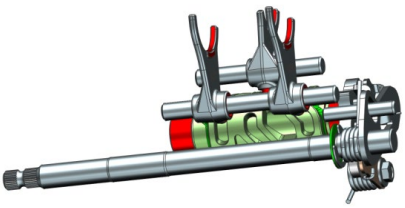
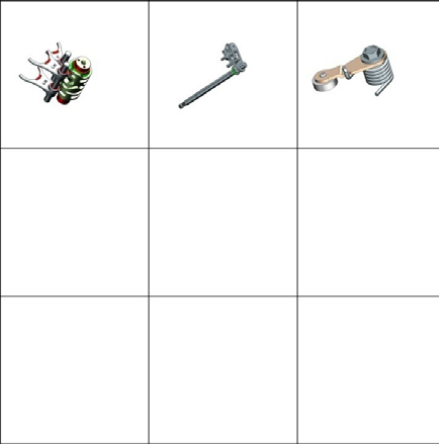
| FIG. | NOMBRE          | IMAGEN CONJUNTO  | IMAGEN DE PARTES   | Nº | CÓDIGO          | DESCRIPCIÓN               | CANT. |
|------|-----------------|--|--|----|-----------------|---------------------------|-------|
| 121  | <u>CILINDRO</u> |   |     | 1  | ZT4050556004000 | Cilindro (Solo)           | 1     |
|      |                 |  |  | 2  | ZT1251513001019 | Arandela 6.3X12X1.6 Cobre | 1     |
|      |                 |  |  | 3  | ZT1251100067093 | Bulon M6X10               | 1     |
|      |                 |  |  | 4  |                 |                           |       |
|      |                 |  |  | 5  |                 |                           |       |
|      |                 |  |  | 6  |                 |                           |       |
|      |                 |  |  | 7  |                 |                           |       |
|      |                 |  |  | 8  |                 |                           |       |
|      |                 |  |  | 9  |                 |                           |       |
| 122  | PISTON          |  |   <br>   | 1  | ZT1050468005000 | Aro 1°                    | 1     |
|      |                 |  |  | 2  | ZT1050468006000 | Aro 2°                    | 1     |
|      |                 |  |  | 3  | ZT1050468007000 | Aro Rasca Aceite          | 1     |
|      |                 |  |  | 4  | ZT1050456001000 | Piston                    | 1     |
|      |                 |  |  | 5  | ZT1050468002000 | Perno Piston              | 1     |
|      |                 |  |  | 6  | ZT1050468001000 | Seguro Perno Piston       | 2     |
|      |                 |  |  | 7  |                 |                           |       |
|      |                 |  |  | 8  |                 |                           |       |
|      |                 |  |  | 9  |                 |                           |       |

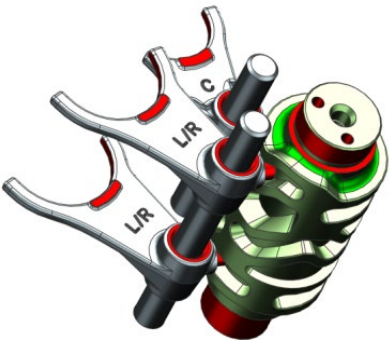
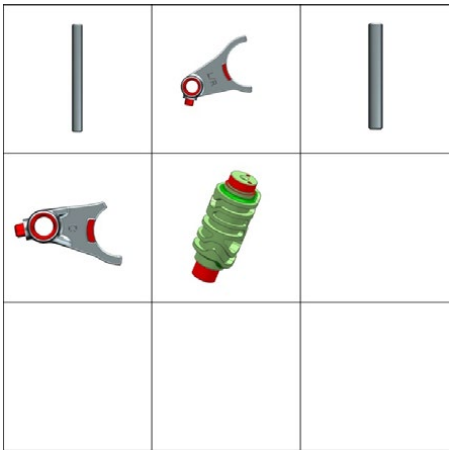
| FIG. | NOMBRE          | IMAGEN CONJUNTO  | IMAGEN DE PARTES  | Nº | CÓDIGO          | DESCRIPCIÓN               | CANT. |
|------|-----------------|--|---|----|-----------------|---------------------------|-------|
| 123  | CAJA DE CAMBIOS |   |   | 1  | ZT1050656012000 | Kit Selectora Completa    | 1     |
|      |                 |  |   | 2  | ZT1050256003000 | Arbol Primario Completo   | 1     |
|      |                 |  |   | 3  | ZT1050256004000 | Arbol Secundario Completo | 1     |
|      |                 |  |   | 4  | ZT1050356016000 | Piñon Z14 (Kit)           | 1     |
|      |                 |  |   | 5  |                 |                           |       |
|      |                 |  |   | 6  |                 |                           |       |
|      |                 |  |   | 7  |                 |                           |       |
|      |                 |  |   | 8  |                 |                           |       |
|      |                 |  |   | 9  |                 |                           |       |
| 124  | SELECTORA       |  |  | 1  |                 |                           | 1     |
|      |                 |  |   | 2  |                 |                           | 1     |
|      |                 |  |   | 3  |                 |                           | 1     |
|      |                 |  |   | 4  |                 |                           |       |
|      |                 |  |   | 5  |                 |                           |       |
|      |                 |  |   | 6  |                 |                           |       |
|      |                 |  |   | 7  |                 |                           |       |
|      |                 |  |   | 8  |                 |                           |       |
|      |                 |  |   | 9  |                 |                           |       |

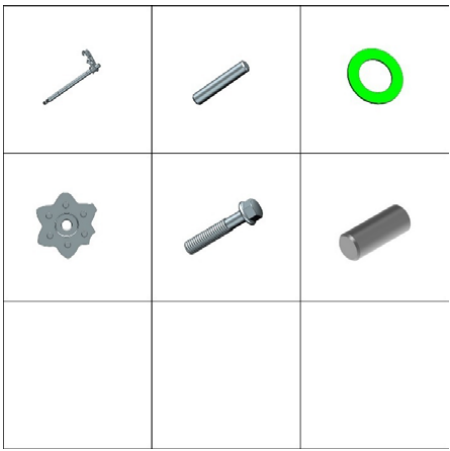
| FIG. | NOMBRE              | IMAGEN CONJUNTO  | IMAGEN DE PARTES  | Nº | CÓDIGO          | DESCRIPCIÓN                        | CANT. |
|------|---------------------|--|---|----|-----------------|------------------------------------|-------|
| 125  | SELECTORA           |   |   | 1  | ZT1050656011000 | Eje Horquillas L/R                 | 1     |
|      |                     |  |   | 2  | ZT1050656002000 | Horquilla L/R                      | 2     |
|      |                     |  |   | 3  | ZT1050651006000 | Horquilla C                        | 1     |
|      |                     |  |   | 4  | ZT1050656001000 | Eje Horquilla C                    | 1     |
|      |                     |  |   | 5  |                 |                                    | 1     |
|      |                     |  |   | 6  |                 |                                    |       |
|      |                     |  |   | 7  |                 |                                    |       |
|      |                     |  |   | 8  |                 |                                    |       |
|      |                     |  |   | 9  |                 |                                    |       |
| 126  | EJE PALANCA CAMBIOS |  |  | 1  | ZT1050656004000 | Eje Palanca Cambios                | 1     |
|      |                     |  |   | 2  | ZT1050656005000 | Eje Resorte Retorno Palanca Cambio | 1     |
|      |                     |  |   | 3  | ZT1251512009000 | Arandela 15.2X25X1                 | 1     |
|      |                     |  |   | 4  | ZT1050651003000 | Placa Selectora                    | 1     |
|      |                     |  |   | 5  | ZT1251112002093 | Bulon M6X30                        | 1     |
|      |                     |  |   | 6  | ZT1250404004000 | Perno 4x10                         | 2     |
|      |                     |  |   | 7  |                 |                                    |       |
|      |                     |  |   | 8  |                 |                                    |       |
|      |                     |  |   | 9  |                 |                                    |       |





| FIG. | NOMBRE             | IMAGEN CONJUNTO | IMAGEN DE PARTES |   |                 | Nº                             | CÓDIGO | DESCRIPCIÓN | CANT. |
|------|--------------------|-----------------|------------------|---|-----------------|--------------------------------|--------|-------------|-------|
| 127  | LEVA SELECTORA     |                 |                  | 1 | ZT1251100068093 | Bulon M6X14 - 9X2.6            | 1      |             |       |
|      |                    |                 |                  | 2 | ZT1260100246000 | Resorte Retorno Leva Selectora | 1      |             |       |
|      |                    |                 |                  | 3 | ZT1050656014000 | Leva Selectora                 | 1      |             |       |
|      |                    |                 |                  | 4 | ZT1251500091000 | Arandela 6.3x12x1              | 1      |             |       |
|      |                    |                 |                  | 5 |                 |                                |        |             |       |
|      |                    |                 |                  | 6 |                 |                                |        |             |       |
|      |                    |                 |                  | 7 |                 |                                |        |             |       |
|      |                    |                 |                  | 8 |                 |                                |        |             |       |
|      |                    |                 |                  | 9 |                 |                                |        |             |       |
| 128  | CACHA TANQUE NEGRO |                 |                  | 1 | ZT1251500089000 | Arandela Estrella Piñon        | 1      |             |       |
|      |                    |                 |                  | 2 | ZT1050356002000 | Piñon Z14                      | 1      |             |       |
|      |                    |                 |                  | 3 | ZT1251500088000 | Arandela Seguro Piñon          | 1      |             |       |
|      |                    |                 |                  | 4 | ZT1251300033094 | Tuerca Piñon M16x1.5           | 1      |             |       |
|      |                    |                 |                  | 5 |                 |                                |        |             |       |
|      |                    |                 |                  | 6 |                 |                                |        |             |       |
|      |                    |                 |                  | 7 |                 |                                |        |             |       |
|      |                    |                 |                  | 8 |                 |                                |        |             |       |
|      |                    |                 |                  | 9 |                 |                                |        |             |       |



| FIG. | NOMBRE             | IMAGEN CONJUNTO | IMAGEN DE PARTES | Nº | CÓDIGO          | DESCRIPCIÓN                           | CANT. |
|------|--------------------|-----------------|------------------|----|-----------------|---------------------------------------|-------|
| 129  | SEMICARTER DERECHO |                 |                  | 1  |                 |                                       |       |
|      |                    |                 |                  | 2  |                 |                                       |       |
|      |                    |                 |                  | 3  |                 |                                       |       |
|      |                    |                 |                  | 4  |                 |                                       |       |
|      |                    |                 |                  | 5  |                 |                                       |       |
|      |                    |                 |                  | 6  |                 |                                       |       |
|      |                    |                 |                  | 7  |                 |                                       |       |
|      |                    |                 |                  | 8  |                 |                                       |       |
|      |                    |                 |                  | 9  |                 |                                       |       |
| 130  | SEMICARTER DERECHO |                 |                  | 1  | ZT4050256000    | SemiCarter Derecho (Perno Aceite)     | 1     |
|      |                    |                 |                  | 2  | ZT1051656003000 | Junta Carter                          | 1     |
|      |                    |                 |                  | 3  | ZT1251112004093 | Bulon M6X60                           | 4     |
|      |                    |                 |                  | 4  | ZT1251112001093 | Bulon M6X16                           | 3     |
|      |                    |                 |                  | 5  | ZT1051356006000 | Placa Presión Rodamiento              | 1     |
|      |                    |                 |                  | 6  | ZT1051356013000 | Seguro Rodamiento Eje Balaceador Der. | 1     |
|      |                    |                 |                  | 7  | ZT1251401001000 | Buje Posicionador 8X14                | 2     |
|      |                    |                 |                  | 8  |                 |                                       |       |
|      |                    |                 |                  | 9  |                 |                                       |       |

| FIG. | NOMBRE             | IMAGEN CONJUNTO | IMAGEN DE PARTES | Nº | CÓDIGO          | DESCRIPCIÓN                         | CANT. |
|------|--------------------|-----------------|------------------|----|-----------------|-------------------------------------|-------|
| 131  | SEMICARTER DERECHO |                 |                  | 1  |                 |                                     | 1     |
|      |                    |                 |                  | 2  | ZT1250601043000 | Rodamiento 6204/P6                  | 1     |
|      |                    |                 |                  | 3  | ZT1250601039000 | Rodamiento 6203/P6                  | 1     |
|      |                    |                 |                  | 4  | ZT1250601098000 | Rodamiento 6202RS/P5                | 1     |
|      |                    |                 |                  | 5  | ZT1051754001000 | Perno 1x5,5x6                       | 1     |
|      |                    |                 |                  | 6  | ZT1051353014000 | Buje trasero Carter Derecho         | 1     |
|      |                    |                 |                  | 7  | #N/D            | #N/D                                | 1     |
|      |                    |                 |                  | 8  | ZT1251111008000 | Esparrago M8X1.25.166               | 2     |
|      |                    |                 |                  | 9  |                 |                                     |       |
| 132  | SEMICARTER DERECHO |                 |                  | 1  | ZT4050256011000 | SemiCarter Derecho (Perno Aceite)V2 | 1     |
|      |                    |                 |                  | 2  |                 |                                     |       |
|      |                    |                 |                  | 3  |                 |                                     |       |
|      |                    |                 |                  | 4  |                 |                                     |       |
|      |                    |                 |                  | 5  |                 |                                     |       |
|      |                    |                 |                  | 6  |                 |                                     |       |
|      |                    |                 |                  | 7  |                 |                                     |       |
|      |                    |                 |                  | 8  |                 |                                     |       |
|      |                    |                 |                  | 9  |                 |                                     |       |

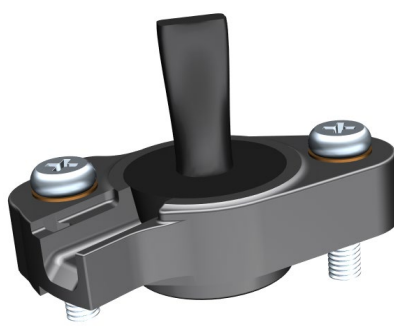
| FIG. | NOMBRE               | IMAGEN CONJUNTO | IMAGEN DE PARTES | Nº | CÓDIGO          | DESCRIPCIÓN                           | CANT. |
|------|----------------------|-----------------|------------------|----|-----------------|---------------------------------------|-------|
| 133  | SEMICARTER IZQUIERDO |                 |                  | 1  |                 |                                       | 1     |
|      |                      |                 |                  | 2  |                 |                                       |       |
|      |                      |                 |                  | 3  |                 |                                       |       |
|      |                      |                 |                  | 4  |                 |                                       |       |
|      |                      |                 |                  | 5  |                 |                                       |       |
|      |                      |                 |                  | 6  |                 |                                       |       |
|      |                      |                 |                  | 7  |                 |                                       |       |
|      |                      |                 |                  | 8  |                 |                                       |       |
|      |                      |                 |                  | 9  |                 |                                       |       |
| 134  | SEMICARTER IZQUIERDO |                 |                  | 1  |                 |                                       | 1     |
|      |                      |                 |                  | 2  |                 |                                       | 1     |
|      |                      |                 |                  | 3  | ZT4050156003000 | SemiCarte Izquierdo (Eje Balanceador) | 1     |
|      |                      |                 |                  | 4  | ZT1251112002093 | Bulon M6X30                           | 2     |
|      |                      |                 |                  | 5  | ZT1251112003093 | Bulon M6X45                           | 7     |
|      |                      |                 |                  | 6  | ZT1251112005093 | Bulon M6X75                           | 1     |
|      |                      |                 |                  | 7  | ZT1251401001000 | Buje Posicionador 8X14                | 4     |
|      |                      |                 |                  | 8  |                 |                                       | 1     |
|      |                      |                 |                  | 9  |                 |                                       |       |

| FIG. | NOMBRE               | IMAGEN CONJUNTO | IMAGEN DE PARTES | Nº | CÓDIGO          | DESCRIPCIÓN                               | CANT. |
|------|----------------------|-----------------|------------------|----|-----------------|---|-------|
| 135  | SEMICARTER IZQUIERDO |                 |                  | 1  |                 |   | 1     |
|      |                      |                 |                  | 2  | ZT1250601036000 | Rodamiento 6202Rs/P6 (Nitruración)        | 1     |
|      |                      |                 |                  | 3  | ZT1250601097000 | Rodamiento 62/22RS/P6                     | 1     |
|      |                      |                 |                  | 4  | ZT1250601060000 | Rodamiento 6207/P53                       | 1     |
|      |                      |                 |                  | 5  | ZT1250602020000 | Rodamiento Aguja Hk22910                  | 1     |
|      |                      |                 |                  | 6  | ZT1251601001000 | Rodamiento 63/13/P5 (6301/13 Nitruración) | 1     |
|      |                      |                 |                  | 7  | ZT1250601098000 | Rodamiento 6202RS/P5                      |       |
|      |                      |                 |                  | 8  | ZT1051353014000 | Buje trasero Carter Derecho               | 1     |
|      |                      |                 |                  | 9  | ZT1050853020000 | Buje Aceite 8x7.5                         | 1     |
|      |                      |                 |                  | 10 | ZT1051556003000 | Reten 22x35x6 en Nitrilo Hidrogenado      | 1     |
|      |                      |                 |                  | 11 | ZT1051553005000 | Retén 14X28X7                             | 1     |
|      |                      |                 |                  | 12 | ZT1051353008000 | Tubo Aire                                 | 1     |
|      |                      |                 |                  | 13 | ZT1251111007000 | Esparrago M8x1,25x208                     | 2     |
|      |                      |                 |                  | 14 |                 |   |       |
|      |                      |                 |                  | 15 |                 |   |       |
|      |                      |                 |                  | 16 |                 |   |       |
|      |                      |                 |                  | 17 |                 |   |       |
|      |                      |                 |                  | 18 |                 |   |       |
|      |                      |                 |                  | 19 |                 |   |       |

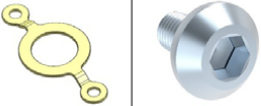

| FIG. | NOMBRE                   | IMAGEN CONJUNTO  | IMAGEN DE PARTES  | Nº | CÓDIGO          | DESCRIPCIÓN                      | CANT. |
|------|--------------------------|--|---|----|-----------------|----------------------------------|-------|
| 136  | SENSOR POSICIÓN CIGÜEÑAL |   |   | 1  | ZT1050956001000 | Sensor Posición Cigüeñal         | 1     |
|      |                          |  |   | 2  | ZT1251201001094 | Bulon M5X15                      | 2     |
|      |                          |  |   | 3  |                 |                                  |       |
|      |                          |  |   | 4  |                 |                                  |       |
|      |                          |  |   | 5  |                 |                                  |       |
|      |                          |  |   | 6  |                 |                                  |       |
|      |                          |  |   | 7  |                 |                                  |       |
|      |                          |  |   | 8  |                 |                                  |       |
|      |                          |  |   | 9  |                 |                                  |       |
| 137  | MODULO DISPLAY ENGRANAJE |  |  | 1  | ZT1050656010000 | Modulo Display Engranaje         | 1     |
|      |                          |  |   | 2  | ZT1051454011000 | O-Ring 22.5X2.5                  | 1     |
|      |                          |  |   | 3  | ZT1050654007000 | Perno Resorte De Placa Selectora | 1     |
|      |                          |  |   | 4  | ZT1250201034093 | Bulon M5X16                      | 2     |
|      |                          |  |   | 5  |                 |                                  |       |
|      |                          |  |   | 6  |                 |                                  |       |
|      |                          |  |   | 7  |                 |                                  |       |
|      |                          |  |   | 8  |                 |                                  |       |
|      |                          |  |   | 9  |                 |                                  |       |

| FIG. | NOMBRE                | IMAGEN CONJUNTO   | IMAGEN DE PARTES   | Nº | CÓDIGO          | DESCRIPCIÓN                     | CANT. |
|------|-----------------------|---|--|----|-----------------|---------------------------------|-------|
| 138  | TAPON DE ACEITE       |    |  | 1  | ZT1251100066093 | Tapón Drenaje Aceite M12X1.5X15 | 1     |
|      |                       |   |  | 2  | ZT1244100033000 | Junta 12X20X2                   | 1     |
|      |                       |   |  | 3  |                 |                                 |       |
|      |                       |   |  | 4  |                 |                                 |       |
|      |                       |   |  | 5  |                 |                                 |       |
|      |                       |   |  | 6  |                 |                                 |       |
|      |                       |   |  | 7  |                 |                                 |       |
|      |                       |   |  | 8  |                 |                                 |       |
|      |                       |   |  | 9  |                 |                                 |       |
| 139  | SEGURO RETEN DE PIÑÓN |  |  | 1  | ZT1051356005000 | Seguro Reten Piñon              | 1     |
|      |                       |   |  | 2  | ZT1251100119093 | Bulon M6X12                     | 2     |
|      |                       |   |  | 3  |                 |                                 |       |
|      |                       |   |  | 4  |                 |                                 |       |
|      |                       |   |  | 5  |                 |                                 |       |
|      |                       |   |  | 6  |                 |                                 |       |
|      |                       |   |  | 7  |                 |                                 |       |
|      |                       |   |  | 8  |                 |                                 |       |
|      |                       |   |  | 9  |                 |                                 |       |

| FIG. | NOMBRE                            | IMAGEN CONJUNTO | IMAGEN DE PARTES | Nº | CÓDIGO          | DESCRIPCIÓN                          | CANT. |
|------|-----------------------------------|-----------------|------------------|----|-----------------|--------------------------------------|-------|
| 140  | CIGÜEÑAL COMPLETO                 |                 |                  | 1  | ZT1050469001000 | Cigüeñal Completo                    | 1     |
|      |                                   |                 |                  | 2  | ZT1251802003000 | Chaveta 4X4.6X25X14                  | 1     |
|      |                                   |                 |                  | 3  | ZT1251802004000 | Chaveta 5X5.5X26X9                   | 1     |
|      |                                   |                 |                  | 4  | ZT1050356013000 | Engranaje de Balanceador             | 1     |
|      |                                   |                 |                  | 5  | ZT1050356014000 | Engranaje Primario                   | 1     |
|      |                                   |                 |                  | 6  | ZT1251514002000 | Arandela Antivibración 10.3X28X2.4X2 | 1     |
|      |                                   |                 |                  | 7  | ZT1251311001094 | Tuerca M16X1                         | 1     |
|      |                                   |                 |                  | 8  | ZT1250601060000 | Rodamiento 6207/P53                  | 1     |
|      |                                   |                 |                  | 9  |                 |                                      |       |
| 141  | SEMICARTER IZQUIERDO CON CIGÜEÑAL |                 |                  | 1  | ZT4050156009000 | SemiCarte Izquierdo C/Cigüeñal       | 1     |
|      |                                   |                 |                  | 2  |                 |                                      |       |
|      |                                   |                 |                  | 3  |                 |                                      |       |
|      |                                   |                 |                  | 4  |                 |                                      |       |
|      |                                   |                 |                  | 5  |                 |                                      |       |
|      |                                   |                 |                  | 6  |                 |                                      |       |
|      |                                   |                 |                  | 7  |                 |                                      |       |
|      |                                   |                 |                  | 8  |                 |                                      |       |
|      |                                   |                 |                  | 9  |                 |                                      |       |

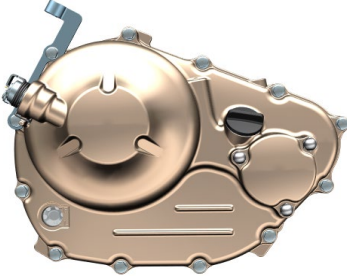
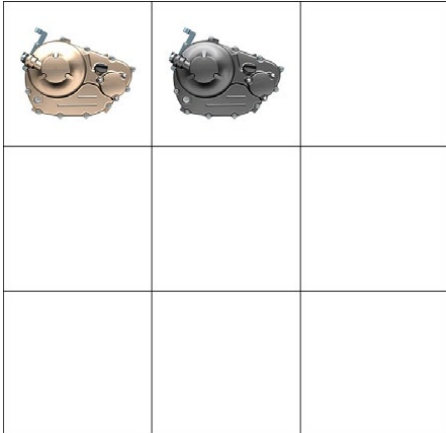

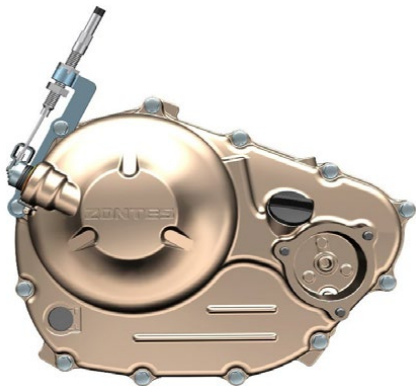

| FIG. | NOMBRE                           | IMAGEN CONJUNTO | IMAGEN DE PARTES | Nº | CÓDIGO          | DESCRIPCIÓN                            | CANT. |
|------|----------------------------------|-----------------|------------------|----|-----------------|--|-------|
| 142  | TAPA CAJA COMPONENTES ELECTRICOS |                 |                  | 1  | ZT1050551002000 | Balanceador OLD                        | 1     |
|      |                                  |                 |                  | 2  | ZT1050556005000 | Balanceador V2                         |       |
|      |                                  |                 |                  | 3  | ZT1050556004000 | Engranaje Contrapeso Balanceador       | 1     |
|      |                                  |                 |                  | 4  | ZT1251802004000 | Chaveta 5X5.5X26X9                     | 1     |
|      |                                  |                 |                  | 5  | ZT1050556001000 | Tapa Eje Balanceador                   | 1     |
|      |                                  |                 |                  | 6  | ZT1251514001000 | Arandela Antivibración 14.2x27x2.1x1.5 | 1     |
|      |                                  |                 |                  | 7  | ZT1251311004094 | Tuerca M14x1                           | 1     |
|      |                                  |                 |                  | 8  |                 |  |       |
|      |                                  |                 |                  | 9  |                 |  |       |
| 143  | TAPA INFERIOR DE COLIN           |                 |                  | 1  | ZT4050968003000 | Tapon Filtro Aceite Malla              | 1     |
|      |                                  |                 |                  | 2  | ZT1051468003000 | O-Ring 34.5x3.5 Adhesivo Acrilato      | 1     |
|      |                                  |                 |                  | 3  | ZT1050868003000 | Resorte Filtro Aceite Malla            | 1     |
|      |                                  |                 |                  | 4  | ZT1050868004000 | Filtro Aceite Malla                    | 1     |
|      |                                  |                 |                  | 5  |                 |  |       |
|      |                                  |                 |                  | 6  |                 |  |       |
|      |                                  |                 |                  | 7  |                 |  |       |
|      |                                  |                 |                  | 8  |                 |  |       |
|      |                                  |                 |                  | 9  |                 |  |       |

| FIG. | NOMBRE        | IMAGEN CONJUNTO   | IMAGEN DE PARTES  | Nº | CÓDIGO | DESCRIPCIÓN | CANT. |
|------|---------------|---|---|----|--------|-------------|-------|
| 144  | TAPA EMBRAGUE |  |  | 1  |        |             | 1     |
|      |               |   |   | 2  |        |             | 1     |
|      |               |   |   | 3  |        |             |       |
|      |               |   |   | 4  |        |             |       |
|      |               |   |   | 5  |        |             |       |
|      |               |   |   | 6  |        |             |       |
|      |               |   |   | 7  |        |             |       |
|      |               |   |   | 8  |        |             |       |
|      |               |   |   | 9  |        |             |       |
|      |               |   |   |    |        |             |       |
|      |               |   |   |    |        |             |       |
|      |               |   |   |    |        |             |       |
|      |               |   |   |    |        |             |       |
|      |               |   |   |    |        |             |       |

| FIG. | NOMBRE              | IMAGEN CONJUNTO  | IMAGEN DE PARTES  | Nº | CÓDIGO          | DESCRIPCIÓN                   | CANT. |
|------|---------------------|--|---|----|-----------------|-------------------------------|-------|
| 145  | TAPA CARTER DERECHO |  |  | 1  | ZT4050456003000 | Tapa Carter Derecho Titanio   | 1     |
|      |                     |  |   | 2  | ZT4050456007051 | Tapa Carter Derecho Gris      |       |
|      |                     |  |   | 3  | ZT1251300054000 | Tapon Carga Aceite M20x1.5    | 1     |
|      |                     |  |   | 4  | ZT1051456003000 | O-Ring 19x2.65                | 1     |
|      |                     |  |   | 5  | ZT1050756013000 | Leva de Eje Comando Embrague  | 1     |
|      |                     |  |   | 6  | ZT1050756012000 | Resorte Retorno Leva Embrague | 1     |
|      |                     |  |   | 7  | ZT1051154003000 | Seguer 10                     | 1     |
|      |                     |  |   | 8  | ZT1051656004000 | Junta Tapa Carter Derecha     | 1     |
|      |                     |  |   | 9  | ZT1051356009000 | Soporte Cable Embrague Motor  | 1     |
|      |                     |  |   | 1  | ZT1251112003093 | Bulon M6X45                   | 3     |
|      |                     |  |   | 2  | ZT1251112002093 | Bulon M6X30                   | 9     |
|      |                     |  |   | 3  | ZT1050756014000 | Eje Comando Embrague          | 1     |
|      |                     |  |   | 4  | ZT1251512043000 | Arandela 14.2x24x0.5          | 1     |
|      |                     |  |   | 5  | ZT1051354013000 | Seguer 24X1                   | 1     |
|      |                     |  |   | 6  | ZT1251512003000 | Arandela 8.2x14x0.5           | 1     |
|      |                     |  |   | 7  | ZT1250511002000 | Seguer E 6x1                  | 1     |
|      |                     |  |   | 8  |                 |                               |       |
|      |                     |  |   | 9  |                 |                               |       |

| FIG. | NOMBRE                  | IMAGEN CONJUNTO | IMAGEN DE PARTES | Nº | CÓDIGO          | DESCRIPCIÓN                                      | CANT. |
|------|-------------------------|-----------------|------------------|----|-----------------|--|-------|
| 146  | TAPA CARTER DERECHO CNC |                 |                  | 1  | ZT4050456016000 | Tapa Carter Derecho Titanio (CNC)                | 1     |
|      |                         |                 |                  | 2  | ZT4050456017051 | Tapa Carter Derecho Gris (CNC)                   |       |
|      |                         |                 |                  | 3  | ZT1251700141000 | Buje Tapa Carter Derecho                         | 1     |
|      |                         |                 |                  | 4  | ZT1050853020000 | Buje Aceite 8x7.5                                | 2     |
|      |                         |                 |                  | 5  | ZT1250602022000 | Rodamiento Aguja Hk1010                          | 1     |
|      |                         |                 |                  | 6  | ZT1250602033000 | Rodamiento Aguja Hk1412                          | 1     |
|      |                         |                 |                  | 7  | ZT1051553002000 | Reten De Aceite Fb 14X22X5 (Nitrilo Hidrogenado) | 2     |
|      |                         |                 |                  | 8  | ZT1051551004000 | Visor Aceite                                     | 1     |
|      |                         |                 |                  | 9  | ZT1251111013000 | Esparrago M6X26.5                                | 3     |
|      |                         |                 |                  | 1  | ZT1250700012000 | Seguer 26  | 1     |
| 147  | TAPA CARTER IZQUIERDO   |                 |                  | 2  |                 |  | 1     |
|      |                         |                 |                  | 3  |                 |  |       |
|      |                         |                 |                  | 4  |                 |  |       |
|      |                         |                 |                  | 5  |                 |  |       |
|      |                         |                 |                  | 6  |                 |  |       |
|      |                         |                 |                  | 7  |                 |  |       |
|      |                         |                 |                  | 8  |                 |  |       |
|      |                         |                 |                  | 9  |                 |  |       |
|      |                         |                 |                  |    |                 |  |       |

| FIG. | NOMBRE                | IMAGEN CONJUNTO | IMAGEN DE PARTES | Nº | CÓDIGO          | DESCRIPCIÓN                   | CANT. |
|------|-----------------------|-----------------|------------------|----|-----------------|-------------------------------|-------|
| 148  | TAPA CARTER IZQUIERDO |                 |                  | 1  | ZT4050953006051 | Tapon M30X1.5 Aluminio        | 1     |
|      |                       |                 |                  | 2  | ZT4050956003051 | Tapon M30X1.5 Aluminio Gris   |       |
|      |                       |                 |                  | 3  | ZT1051453003000 | O-Ring 27.4X2.65              | 1     |
|      |                       |                 |                  | 4  | ZT1040953002093 | Tapon M14X1.5                 | 1     |
|      |                       |                 |                  | 5  | ZT1051453009000 | O-Ring 13X2.8                 | 1     |
|      |                       |                 |                  | 6  | ZT4050356002000 | Tapa Carter Izquierdo Titanio | 1     |
|      |                       |                 |                  | 7  | ZT4050356003051 | Tapa Carter Izquierdo Gris    |       |
|      |                       |                 |                  | 8  | ZT1051656005000 | Junta Tapa Carter Izquierda   | 1     |
|      |                       |                 |                  | 9  | ZT1251112003093 | Bulon M6X45                   | 7     |
| 149  | TAPA FILTRO ACEITE    |                 |                  | 1  |                 |                               |       |
|      |                       |                 |                  | 2  | ZT1051466016000 | Junta Sello Filtro Aceite     | 1     |
|      |                       |                 |                  | 3  | ZT4050456006000 | Tapa Filtro Aceite Titanio    | 1     |
|      |                       |                 |                  | 4  | ZT4050456008051 | Tapa Filtro Aceite Gris       |       |
|      |                       |                 |                  | 5  | ZT1050868002000 | Resorte Filtro Aceite         | 1     |
|      |                       |                 |                  | 6  | ZT1051456007000 | O-Ring 49x2.5 Filtro Aceite   | 1     |
|      |                       |                 |                  | 7  | ZT4131200002000 | Filtro Aceite KIT             | 1     |
|      |                       |                 |                  | 8  | ZT1251300096000 | Tuerca M6                     | 3     |
|      |                       |                 |                  | 9  |                 |                               |       |

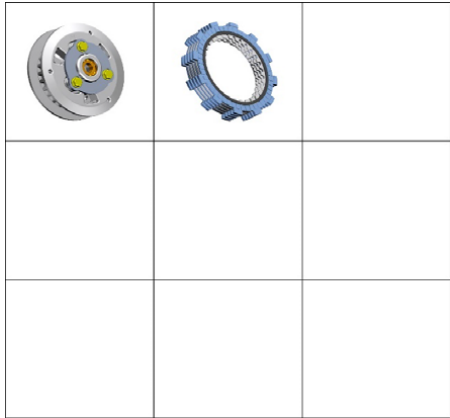
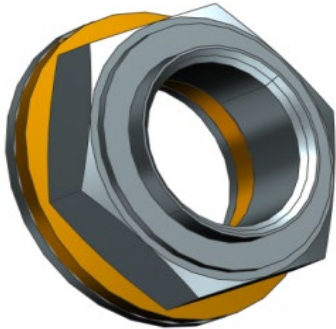
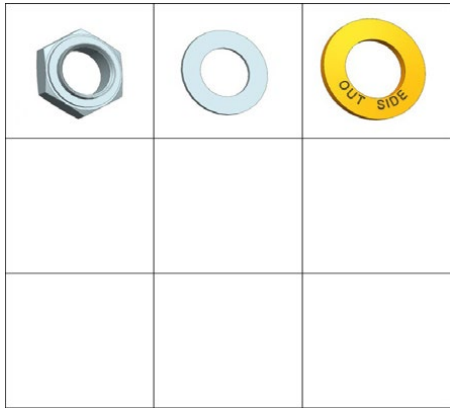

| FIG. | NOMBRE            | IMAGEN CONJUNTO  | IMAGEN DE PARTES  | Nº | CÓDIGO          | DESCRIPCIÓN                 | CANT. |
|------|-------------------|--|---|----|-----------------|-----------------------------|-------|
| 150  | EMBRAGUE COMPLETO |   |   | 1  |                 |                             | 1     |
|      |                   |  |   | 2  |                 |                             |       |
|      |                   |  |   | 3  |                 |                             |       |
|      |                   |  |   | 4  |                 |                             |       |
|      |                   |  |   | 5  |                 |                             |       |
|      |                   |  |   | 6  |                 |                             |       |
|      |                   |  |   | 7  |                 |                             |       |
|      |                   |  |   | 8  |                 |                             |       |
|      |                   |  |   | 9  |                 |                             |       |
| 151  | EMBRAGUE COMPLETO |  |  | 1  | ZT1251700148000 | Buje Canasta Embrague       | 1     |
|      |                   |  |   | 2  | ZT1251602001000 | Rodmiento Aguja 263124      | 1     |
|      |                   |  |   | 3  | ZT1050756008000 | Canasta Embrague            | 1     |
|      |                   |  |   | 4  | ZT1251500084000 | Arandela Embrague           | 1     |
|      |                   |  |   | 5  | ZT1050756028000 | Embrague Completo S/Canasta | 1     |
|      |                   |  |   | 6  |                 |                             | 1     |
|      |                   |  |   | 7  | ZT1251512038000 | Arandela 20.2x37x2          | 1     |
|      |                   |  |   | 8  | ZT1050756015000 | Perno Dentado Embrague      | 1     |
|      |                   |  |   | 9  |                 |                             |       |

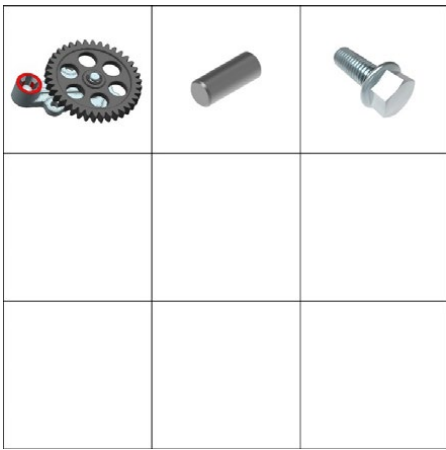
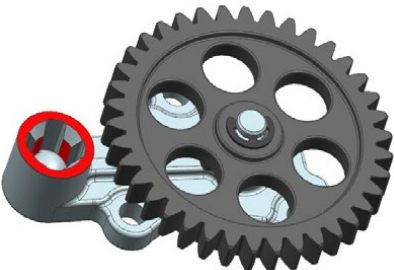
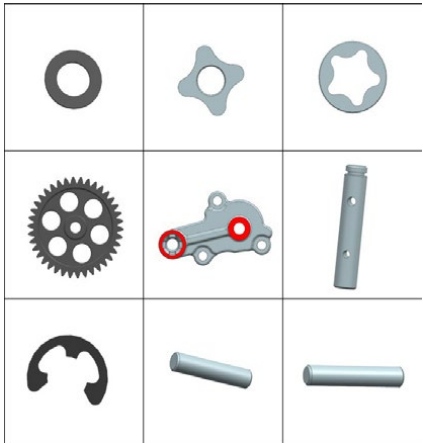
| FIG. | NOMBRE              | IMAGEN CONJUNTO  | IMAGEN DE PARTES  | Nº | CÓDIGO          | DESCRIPCIÓN                          | CANT. |
|------|---------------------|--|---|----|-----------------|--------------------------------------|-------|
| 152  | DISCO EMBREGUE KIT  |   |   | 1  | ZT1050756049000 | Porta Disco Embrague                 | 1     |
|      |                     |  |   | 2  | ZT1050756050000 | Discos Embrague Kit                  | 1     |
|      |                     |  |   | 3  |                 |                                      |       |
|      |                     |  |   | 4  |                 |                                      |       |
|      |                     |  |   | 5  |                 |                                      |       |
|      |                     |  |   | 6  |                 |                                      |       |
|      |                     |  |   | 7  |                 |                                      |       |
|      |                     |  |   | 8  |                 |                                      |       |
|      |                     |  |   | 9  |                 |                                      |       |
| 153  | TUERCA M16 EMBRAGUE |  |  | 1  | ZT1251311001094 | Tuerca M16X1                         | 1     |
|      |                     |  |   | 2  | ZT1251512039000 | Arandela 16.2x28x1.5                 | 1     |
|      |                     |  |   | 3  | ZT1251514002000 | Arandela Antivibración 10.3X28X2.4X2 | 1     |
|      |                     |  |   | 4  |                 |                                      |       |
|      |                     |  |   | 5  |                 |                                      |       |
|      |                     |  |   | 6  |                 |                                      |       |
|      |                     |  |   | 7  |                 |                                      |       |
|      |                     |  |   | 8  |                 |                                      |       |
|      |                     |  |   | 9  |                 |                                      |       |

| FIG. | NOMBRE                    | IMAGEN CONJUNTO  | IMAGEN DE PARTES  | Nº | CÓDIGO          | DESCRIPCIÓN            | CANT. |
|------|---------------------------|--|---|----|-----------------|------------------------|-------|
| 154  | BOMBA DE ACEITE           |   |   | 1  | ZT1050856001000 | Bomba Aceite Completo  | 1     |
|      |                           |  |   | 2  | ZT1250404004000 | Perno 19.2x4x10        | 2     |
|      |                           |  |   | 3  | ZT1251112001093 | Bulon M6X16            | 3     |
|      |                           |  |   | 4  |                 |                        |       |
|      |                           |  |   | 5  |                 |                        |       |
|      |                           |  |   | 6  |                 |                        |       |
|      |                           |  |   | 7  |                 |                        |       |
|      |                           |  |   | 8  |                 |                        |       |
|      |                           |  |   | 9  |                 |                        |       |
| 155  | ENGRANAJE BOMBA DE ACEITE |  |  | 1  |                 |                        | 1     |
|      |                           |  |   | 2  |                 |                        | 1     |
|      |                           |  |   | 3  |                 |                        | 1     |
|      |                           |  |   | 4  | ZT1050356001000 | Engranaje Bomba Aceite | 1     |
|      |                           |  |   | 5  |                 |                        | 1     |
|      |                           |  |   | 6  |                 |                        | 1     |
|      |                           |  |   | 7  |                 |                        | 1     |
|      |                           |  |   | 8  |                 |                        | 1     |
|      |                           |  |   | 9  |                 |                        | 1     |

| FIG. | NOMBRE                     | IMAGEN CONJUNTO | IMAGEN DE PARTES | Nº | CÓDIGO          | DESCRIPCIÓN                  | CANT. |
|------|----------------------------|-----------------|------------------|----|-----------------|------------------------------|-------|
| 156  | SISTEMA DE ARRANQUE        |                 |                  | 1  | ZT1251512025000 | Arandela 22.2x40x1           | 2     |
|      |                            |                 |                  | 2  | ZT1051056007000 | Engranaje Arranque           | 1     |
|      |                            |                 |                  | 3  | ZT1251602002000 | Rodamiento Aguja K22x28x23   | 1     |
|      |                            |                 |                  | 4  | ZT1051056004000 | Engranaje Doble Arranque     | 1     |
|      |                            |                 |                  | 5  | ZT1051068012000 | Eje Engranaje Doble Arranque | 1     |
|      |                            |                 |                  | 6  | ZT1051056005000 | Motor de Arranque            | 1     |
|      |                            |                 |                  | 7  | ZT1251112002093 | Bulon M6X30                  | 2     |
|      |                            |                 |                  | 8  |                 |                              |       |
|      |                            |                 |                  | 9  |                 |                              |       |
| 157  | VOLANTE MAGNETICO COMPLETO |                 |                  | 1  | ZT1051056001000 | Bobina Volante Magnetico     | 1     |
|      |                            |                 |                  | 2  | ZT1051056002000 | Volante Magnetico            | 1     |
|      |                            |                 |                  | 3  | ZT1051356008000 | Placa Presión Bobina         | 1     |
|      |                            |                 |                  | 4  | ZT1251500041000 | Arandela 10.3X20X2           | 1     |
|      |                            |                 |                  | 5  | ZT1251100064094 | Bulon M10x45x1.25            | 1     |
|      |                            |                 |                  | 6  | ZT1251201002094 | Bulon M6X35                  | 3     |
|      |                            |                 |                  | 7  | ZT1251201001094 | Bulon M5X15                  | 2     |
|      |                            |                 |                  | 8  |                 |                              |       |
|      |                            |                 |                  | 9  |                 |                              |       |

| FIG. | NOMBRE                           | IMAGEN CONJUNTO | IMAGEN DE PARTES | Nº | CÓDIGO          | DESCRIPCIÓN                       | CANT. |
|------|----------------------------------|-----------------|------------------|----|-----------------|-----------------------------------|-------|
| 158  | SISTEMA DE DISTRIBUCIÓN          |                 |                  | 1  | ZT1050151023000 | Cadena Distribución 6.35x5x96     | 1     |
|      |                                  |                 |                  | 2  |                 |                                   | 1     |
|      |                                  |                 |                  | 3  |                 |                                   | 1     |
|      |                                  |                 |                  | 4  | ZT1051256005000 | Tensor Cadena Distribución        | 1     |
|      |                                  |                 |                  | 5  | ZT1051668006000 | Junta Tensor Cadena               | 1     |
|      |                                  |                 |                  | 6  | ZT1051256002000 | Patin Guía Cadena Distribución    | 1     |
|      |                                  |                 |                  | 7  | ZT1051256003000 | Placa Presión Cadena Distribución | 1     |
|      |                                  |                 |                  | 8  | ZT1251100067093 | Bulon M6X10                       | 2     |
|      |                                  |                 |                  | 9  | ZT1251100061093 | Bulon M6X22                       | 2     |
| 159  | PATIN TENSOR CADENA DISTRIBUCIÓN |                 |                  | 1  | ZT1051256001000 | Patin Tensor Cadena Distribución  | 1     |
|      |                                  |                 |                  | 2  | ZT1251100165000 | Bulon Pivot M6x16-13.8X8.7        | 1     |
|      |                                  |                 |                  | 3  |                 |                                   |       |
|      |                                  |                 |                  | 4  |                 |                                   |       |
|      |                                  |                 |                  | 5  |                 |                                   |       |
|      |                                  |                 |                  | 6  |                 |                                   |       |
|      |                                  |                 |                  | 7  |                 |                                   |       |
|      |                                  |                 |                  | 8  |                 |                                   |       |
|      |                                  |                 |                  | 9  |                 |                                   |       |

| FIG. | NOMBRE                    | IMAGEN CONJUNTO  | IMAGEN DE PARTES  | Nº | CÓDIGO          | DESCRIPCIÓN               | CANT. |
|------|---------------------------|--|---|----|-----------------|---------------------------|-------|
| 160  | PIÑÓN CADENA DISTRIBUCIÓN |  |  | 1  | ZT1050156002000 | Piñon Cadena Distribución | 1     |
|      |                           |  |   | 2  | ZT1251100164093 | Bulon Piñon - Arbol Levas | 1     |
|      |                           |  |   | 3  | ZT1050168001000 | Palanca de Descompresión  | 1     |
|      |                           |  |   | 4  |                 |                           |       |
|      |                           |  |   | 5  |                 |                           |       |
|      |                           |  |   | 6  |                 |                           |       |
|      |                           |  |   | 7  |                 |                           |       |
|      |                           |  |   | 8  |                 |                           |       |
|      |                           |  |   | 9  |                 |                           |       |
|      |                           |  |   | 1  |                 |                           |       |
|      |                           |  |   | 2  |                 |                           |       |
|      |                           |  |   | 3  |                 |                           |       |
|      |                           |  |   | 4  |                 |                           |       |
|      |                           |  |   | 5  |                 |                           |       |
|      |                           |  |   | 6  |                 |                           |       |
|      |                           |  |   | 7  |                 |                           |       |
|      |                           |  |   | 8  |                 |                           |       |
|      |                           |  |   | 9  |                 |                           |       |



Jorge Peralta Martínez 2330, Los Troncos del Talar - CP. 1618 (B1608FEH) - Tigre, Buenos Aires, Argentina



betamotorargentina



www.betamotor.com.ar